



DISTRIBUZIONE

ACCESSORI PER CALDAIE
VMC
ACCESSORI PER CONDIZIONAMENTO
E PER SOLARE TERMICO

BOILERS FLUE SYSTEMS
SOLAR - CMV SYSTEMS
AIR CONDITIONING AND PLUMBING
ACCESSORIES

GROPPALLI

03/2026 Rev. 10

CHI SIAMO OUR COMPANY

GROPPALLI DISTRIBUZIONE nasce nel 2022 dall'acquisizione della Tekfumi S.r.l. per distribuire sul mercato italiano i prodotti a marchio FIG S.I., società del gruppo Groppalli S.r.l. che dal 1966 è specializzata nella fabbricazione di condotti per lo scarico dei fumi di caldaie e scaldabagni a gas e gasolio, tradizionali ed a condensazione.

GROPPALLI DISTRIBUZIONE was born in 2022 after the acquisition of Tekfumi S.r.l. to distribute FIG S.I. branded products on the Italian Market. Fig S.I. is a Groppalli's. Group company specialized in the production of flue pipes for traditional and condensing boilers and it has been operating since 1966.

QUALITÀ E SERVIZIO - QUALITY AND SERVICE

La forza di GROPPALLI DISTRIBUZIONE consiste in un eccellente servizio, grazie a sistemi di automazione che rendono rapidi i tempi di risposta alle esigenze della clientela. Una lunga esperienza nel settore consente di elaborare la soluzione migliore per ogni tipo di necessità. I più alti standard qualitativi sono sempre garantiti durante tutta la fase produttiva.

GROPPALLI DISTRIBUZIONE 's strength is based on the highest products quality standards and results into an excellent service thanks to automated systems that lead to fast deliveries and customers satisfaction.

The experience on the field allows to find the best solutions for all customers' needs.

IMBALLO FUNZIONALE – FUNTIONAL PACKAGING

I prodotti ad elevata rotazione, oltre a presentare un imballo standard in cartone, sono confezionati in un apposito film termo-retrato utile sia a preservarne l'integrità sia ad agevolarne la vendita al dettaglio.

The high-rotation products are heat shrink wrapped; this film is very useful both to preserve the integrity of products and to facilitate the retail sales.

PRECISIONE E PUNTUALITÀ – ALWAYS ON TIME

Il team di GROPPALLI DISTRIBUZIONE è a vostra disposizione: le richieste dei clienti sono processate in maniera rapida e funzionale. L'ordine effettuato sarà così consegnato nel minor tempo possibile. Qualità del prodotto, attenzione al cliente e velocità...

GROPPALLI DISTRIBUZIONE 's team is at your disposal: the requests of customers are processed quickly and carefully. Every order will be delivered in the shortest time possible thanks to the extensive warehouse stock.

CERTIFICAZIONI CERTIFICATIONS



1 Certificazione linea condensazione
Condensing line certification

2 Certificazione linea tradizionale
Traditional line certification

3 Certificazione camera aperta
Open-flue boiler certification

4 Dichiarazione di prestazione (DOP)
Declaration of performance (DOP)

LINEA CONDENSAZIONE
FLUE PIPES FOR CONDENSING BOILERS

SISTEMA FLESSIBILE – FLEXIBLE SYSTEM	PAG. 5 - 8
SISTEMA MONOPARETE – SINGLE WALL SYSTEM	PAG. 8 - 19
SISTEMA COASSIALE – DOUBLE WALL SYSTEM	PAG. 20 - 23
SISTEMA COIBENTATO – INSULATED SYSTEM	PAG. 24 - 27
KIT COMPATIBILI – COMPATIBLE KITS	PAG. 28 - 37



LINEA TRADIZIONALE
FLUE PIPES FOR TRADITIONAL BOILERS

SISTEMA MONOPARETE – SINGLE WALL SYSTEM	PAG. 38 - 42
SISTEMA COASSIALE – DOUBLE WALL SYSTEM	PAG. 43 - 46
KIT COMPATIBILI – COMPATIBLE KITS	PAG. 47 - 52

ACCESSORI PER CONDIZIONAMENTO
ACCESSORIES FOR CONDITIONING SYSTEMS

LINEA STAFFE – SUPPORT BRACKETS	PAG. 54
SUPPORTI A PAVIMENTO – FLOOR SUPPORTS	PAG. 55 - 56
CANALINE – DUCTS	PAG. 56 - 59
TUBO SCARICO CONDENSA RIGIDO – RIGID CONDENSATE DRAIN PIPE	PAG. 60 - 61
TUBO SCARICO CONDENSA FLESSIBILE – FLEXIBLE CONDENSATE DRAIN PIPE	PAG. 62 - 63
NASTRI ANTICONDENSA – CONDENSATE TAPES	PAG. 64
VASCHETTA RECUPERO CONDENSA – CONDENSATE BOXES	PAG. 64
RACCORDERIA – FITTINGS	PAG. 65 - 66



POMPE SCARICO CONDENSA
CONDENSATE DRAIN PUMPS

PER CONDIZIONATORI E PER CALDAIE – SUITABLE FOR AIR CONDITIONING & BOILERS	PAG. 67-68
--	------------

VMC – VENTILAZIONE MECCANICA CONTROLLATA
CMV – CONTROLLED MECHANICAL VENTILATION

PAG. 69-88

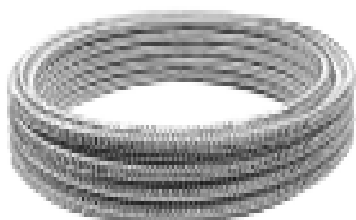

TUBO CSST E ACCESSORI
CSST TUBE AND FITTINGS

PAG. 89-92

ACCESSORI PER IL TERMODINAMICO
ACCESSORIES FOR THERMODYNAMIC SYSTEMS

GLICOLE POLIPROPILENICO – PROPYLENE GLYCOL	PAG. 93
--	---------



LINEA

CONDENSAZIONE

FLUE PIPES FOR CONDENSING BOILERS

SISTEMA FLESSIBILE
SISTEMA MONOPARETE
SISTEMA COASSIALE
SISTEMA COIBENTATO
KIT COMPATIBILI

*FLEXIBLE SYSTEM
SINGLE WALL SYSTEM
DOUBLE WALL SYSTEM
INSULATED SYSTEM
COMPATIBLE KITS*



GROPPALLI
FLUE SYSTEMS
DISTRIBUZIONE

SISTEMA FLESSIBILE – ESEMPIO DI INSTALLAZIONE

FLEXIBLE SYSTEM – INSTALLATION EXAMPLE

Designazione Prodotto: **T120-H1-W-2-O-20-LI-E-U**

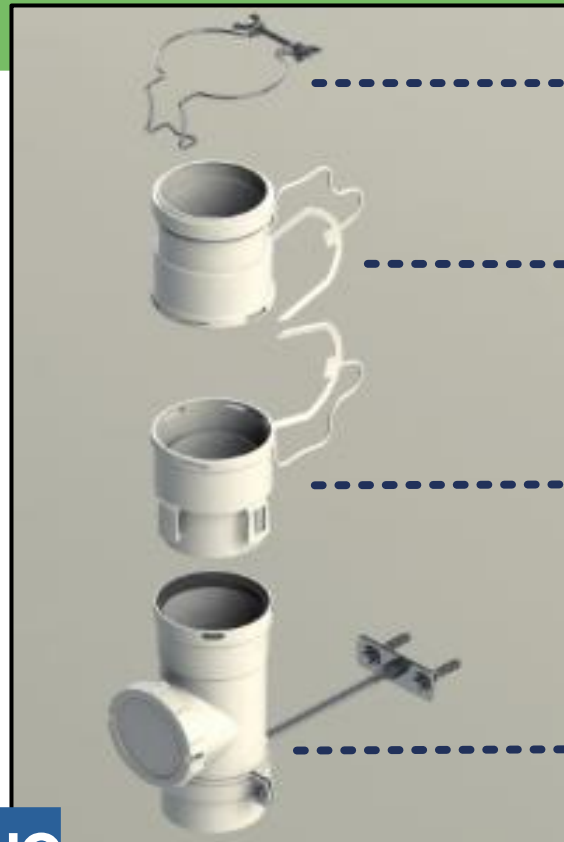

8ABSOPORTFLEX5

8UNIONFLEX5

8UNIONFLEX5

8IV5

**DAL Ø50 FINO
AL Ø200**



8-90MH5NERA

8DFHALL5

SOPORTEHOR250



SISTEMA FLESSIBILE IN PRESSIONE H1: 5000 Pa

FLEXIBLE SYSTEM - PRESSURE CLASS H1: 5000 Pa

IMMAGINE IMG	DESCRIZIONE DESCRIPTION	SPECIFICHE SPECIFICATIONS	CODICE PART NUMBER	DIAMETRO DIAMETER	PZ per SCA PCS per BOX	PREZZO LISTINO LIST PRICE (€)
	Tubo Flessibile <i>Flexible Pipe</i> Necessita adattatori <i>Adapters needed</i> Solo per installazioni verticali <i>For vertical installations only</i>	Polipropilene bianco <i>White polypropylene</i>	5FLEXCONT5	Ø50 - 20 m	4	163,73
			5-50FLEXCONT5	Ø50 - 50 m	4	409,30
			6FLEXCONT5	Ø60 - 20 m	4	158,91
			6-50FLEXCONT5	Ø60 - 50 m	2	397,26
			8FLEXCONT5	Ø80 - 20 m	3	165,53
			8-50FLEXCONT5	Ø80 - 50 m	2	413,82
			10FLEXCONT5	Ø100 - 20 m	2	249,19
			10-50FLEXCONT5	Ø100 - 50 m	2	622,97
			125FLEXCONT5	Ø125 - 20 m	2	380,50
			160FLEXCONT5_10	Ø160 - 10 m	-	216,50
			160FLEXCONT5	Ø160 - 20 m	-	466,00
200FLEXCONT5	Ø200 - 20 m	-	902,87			
	Adattatori per tubo flessibile <i>Flexible pipe adapters</i> 1 Maschio e 1 Femmina <i>1 Male and 1 female</i>	Polipropilene bianco <i>White polypropylene</i> Guarnizione in EPDM <i>EPDM seals</i>	5UNIONFLEX5	Ø50	1	11,38
			6UNIONFLEX5	Ø60	1	11,38
			8UNIONFLEX5	Ø80	1	12,46
			10UNIONFLEX5	Ø100	1	20,05
			125UNIONFLEX5	Ø125	1	30,34
			160UNIONFLEX5	Ø160	1	104,18
			200UNIONFLEX5	Ø200	1	119,81
	Tubo Flessibile <i>Flexible Pipe</i> Necessita adattatori <i>Adapters needed</i> Solo per installazioni verticali <i>For vertical installations only</i>	Polipropilene nero <i>Black polypropylene</i> * Chiedere disponibilità * Ask for availability	5FLEXCONT5-NERO	Ø50 - 20 m	4	171,92
			5-50FLEXCONT5-NERO	Ø50 - 50 m	4	429,77
			6FLEXCONT5-NERO	Ø60 - 20 m	4	166,86
			6-50FLEXCONT5-NERO	Ø60 - 50 m	2	417,12
			8FLEXCONT5-NERO	Ø80 - 20 m	3	173,81
			8-50FLEXCONT5-NERO	Ø80 - 50 m	2	434,50
			10FLEXCONT5-NERO	Ø100 - 20 m	2	261,65
			10-50FLEXCONT5-NERO*	Ø100 - 50 m	2	654,12
	Adattatori per tubo flessibile <i>Flexible pipe adapters</i> 1 Maschio e 1 Femmina <i>1 Male and 1 female</i>	Polipropilene nero <i>Black polypropylene</i> Guarnizione in EPDM <i>EPDM seals</i>	5UNIONFLEX5-NERO	Ø50	1	11,95
			6UNIONFLEX5-NERO	Ø60	1	11,95
			8UNIONFLEX5-NERO	Ø80	1	13,08
			10UNIONFLEX5-NERO	Ø100	1	21,05
	Ricambio adattatore FEMMINA <i>1 female spare part</i> Femmina <i>Female</i>	Polipropilene bianco <i>White polypropylene</i> Guarnizione in EPDM <i>EPDM seals</i>	6-RIC.ADAT.F	Ø60	10	7,60
			8-RIC.ADAT.F	Ø80	10	8,22
	Ricambio adattatore MASCHIO <i>1 male spare part</i> Maschio <i>Male</i>	Polipropilene nero <i>Black polypropylene</i> Guarnizione in EPDM <i>EPDM seals</i>	6-RIC.ADAT.F-NERO	Ø60	10	8,00
			8-RIC.ADAT.F-NERO	Ø80	10	8,65
	Ricambio adattatore MASCHIO <i>1 male spare part</i> Maschio <i>Male</i>	Polipropilene bianco <i>White polypropylene</i> Guarnizione in EPDM <i>EPDM seals</i>	6-RIC.ADAT.M	Ø60	10	7,60
			8-RIC.ADAT.M	Ø80	10	8,22
	Ricambio adattatore MASCHIO <i>1 male spare part</i> Maschio <i>Male</i>	Polipropilene nero <i>Black polypropylene</i> Guarnizione in EPDM <i>EPDM seals</i>	6-RIC.ADAT.M-NERO	Ø60	10	8,00
			8-RIC.ADAT.M-NERO	Ø80	10	8,65
	Tee con mensola di supporto <i>Tee adapter with support bracket</i> Maschio/maschio/femmina <i>Male/male/female</i> * Chiedere disponibilità * Ask for availability	Polipropilene bianco <i>White polypropylene</i> Guarnizione in EPDM <i>EPDM seals</i>	6TESOPORTE5 *	Ø60	1	43,77
			8TESOPORTE5 *	Ø80	1	43,77
			10TESOPORTE5 *	Ø100	1	50,87
	Curva 90° con mensola di supporto <i>90° elbow with support bracket</i> Maschio/femmina <i>Male/female</i> * Chiedere disponibilità * Ask for availability	Polipropilene bianco <i>White polypropylene</i> Guarnizione in EPDM <i>EPDM seals</i>	5CODOSOPORTE5	Ø50	1	48,76
			6CODOSOPORTE5	Ø60	1	42,13
			8CODOSOPORTE5	Ø80	1	42,52
			10CODOSOPORTE5	Ø100	1	45,74
			125CODOSOPORTE5 *	Ø125	1	69,22
			160CODOSOPORTE5 *	Ø160	1	78,55
			200CODOSOPORTE5 *	Ø200	1	85,71



IMMAGINE IMG	DESCRIZIONE DESCRIPTION	SPECIFICHE SPECIFICATIONS	CODICE PART NUMBER	DIAMETRO DIAMETER	PZ per SCA PCS per BOX	PREZZO LISTINO LIST PRICE (€)
	Terminale per tubo flessibile <i>Roof terminal for flexible pipes</i> Aspirazione ed evacuazione <i>Aspiration and Evacuation</i>	PP e PVC neri <i>Black PP and PVC</i> RESISTENTE AI RAGGI U.V. <i>U.V. RESISTANT</i>	5COPPOFLEX5	Ø50	1	123,75
			6COPPOFLEX5	Ø60	1	97,26
			8COPPOFLEX5	Ø80	1	113,64
			10COPPOFLEX5	Ø100	1	119,62
			125COPPOFLEX5	Ø125	1	126,16
	Terminale doppio per tubo flessibile <i>Duble roof terminal for flexible pipes</i> Aspirazione ed evacuazione <i>Aspiration and Evacuation</i>	PP e PVC neri <i>Black PP and PVC</i> RESISTENTE AI RAGGI U.V. <i>U.V. RESISTANT</i>	8COPPOFLEXDOPPIO	Ø80	1	178,50
	Terminale triplo per tubo flessibile <i>Triple roof terminal for flexible pipes</i> Aspirazione ed evacuazione <i>Aspiration and Evacuation</i>	PP e PVC neri <i>Black PP and PVC</i> RESISTENTE AI RAGGI U.V. <i>U.V. RESISTANT</i>	8COPPOFLEXTRIPLO	Ø80	1	321,50
	Collare a di Bloccaggio <i>Locked clamp</i>	Acciaio verniciato bianco <i>White coated steel</i>	6ABSOPORTMURO	Ø60	1	9,43
			8ABSOPORTMURO	Ø80	1	9,87
			10ABSOPORTMURO	Ø100	1	14,51
	Collare per supporto orizzontale <i>Horizontal support bracket</i>	Acciaio zincato <i>Galvanized Steel</i>	SOPORTEHOR250	Da Ø50 a Ø160	1	27,41
	Collare di serraggio <i>Locking collar</i>	Acciaio zincato <i>Galvanized Steel</i>	5ABSOPORTFLEX	Ø50	1	10,73
			6ABSOPORTFLEX	Ø60	1	9,76
			8ABSOPORTFLEX	Ø80	1	9,86
			10ABSOPORTFLEX	Ø100	1	10,62
			125ABSOPORTFLEX	Ø125	1	13,54
			160ABSOPORTFLEX	Ø160	1	21,90
	Curva di supporto 45° con piastra <i>45° elbow with anchoring and plate</i>	Polipropilene bianco <i>White polypropylene</i> Guarnizione in EPDM <i>EPDM seals</i>	6-45CODOSOPORTE5	Ø60/100 in Ø60	1	49,31
			8-45CODOSOPORTE5	Ø80/125 in Ø80	1	51,23
			6108-45CODOSOPORTE5	Ø60/100 in Ø80	1	55,38
	Tappo per curva di supporto 45° <i>Cap for 45° elbow with anchoring</i> Femmina <i>Female</i> * Chiedere disponibilità * Ask for availability	Polipropilene bianco <i>White polypropylene</i> Guarnizione in EPDM <i>EPDM seals</i>	100TAPESOPORTE5 *	Ø100	1	15,89
			125TAPESOPORTE5 *	Ø125	1	19,93
	Centratore per tubo flessibile <i>Flexible pipe spacer</i> Consigliato 1 pz al metro <i>1 piece every meter recommended</i>	Nylon nero <i>Black Nylon</i>	5CENTFLEX	Ø50	4	10,54
			6CENTFLEX	Ø60	5	7,36
			8CENTFLEX	Ø80	5	7,36
			10CENTFLEX	Ø100	5	7,36
			125CENTFLEX	Ø125	5	16,01
			GRANCENTFLEX	da Ø160 a Ø300	1	19,93

	Guarnizione linea condensazione <i>Seal for condensing line</i>	EPDM nero <i>Black EPDM</i>	5JT6	Ø50	10	2,91
			6JT6	Ø60	10	2,32
			8JT6	Ø80	10	2,91
			10JT6	Ø100	10	4,52
			11JT6	Ø110	10	4,52
			125JT6	Ø125	10	5,09
			160JT6	Ø160	10	5,53
			200JT6	Ø200	10	6,12
			250JT6	Ø250	10	6,61
			300JT6	Ø300	10	7,25
	O-ring linea condensazione per tubo flessibile <i>Condensing o-ring for flexible pipe</i>	EPDM nero <i>Black EPDM</i>	5JTUNIONFLEX5	Ø50	10	2,11
			6JTUNIONFLEX5	Ø60	10	2,95
			8JTUNIONFLEX5	Ø80	10	3,36
			10JTUNIONFLEX5	Ø100	10	3,80



GROPPALLI
FLUE SYSTEMS
DISTRIBUZIONE

SISTEMA RIGIDO – ESEMPIO DI INSTALLAZIONE
RIGID SYSTEM – INSTALLATION EXAMPLE

T120-H1-W-2-O-20-LI-E-U







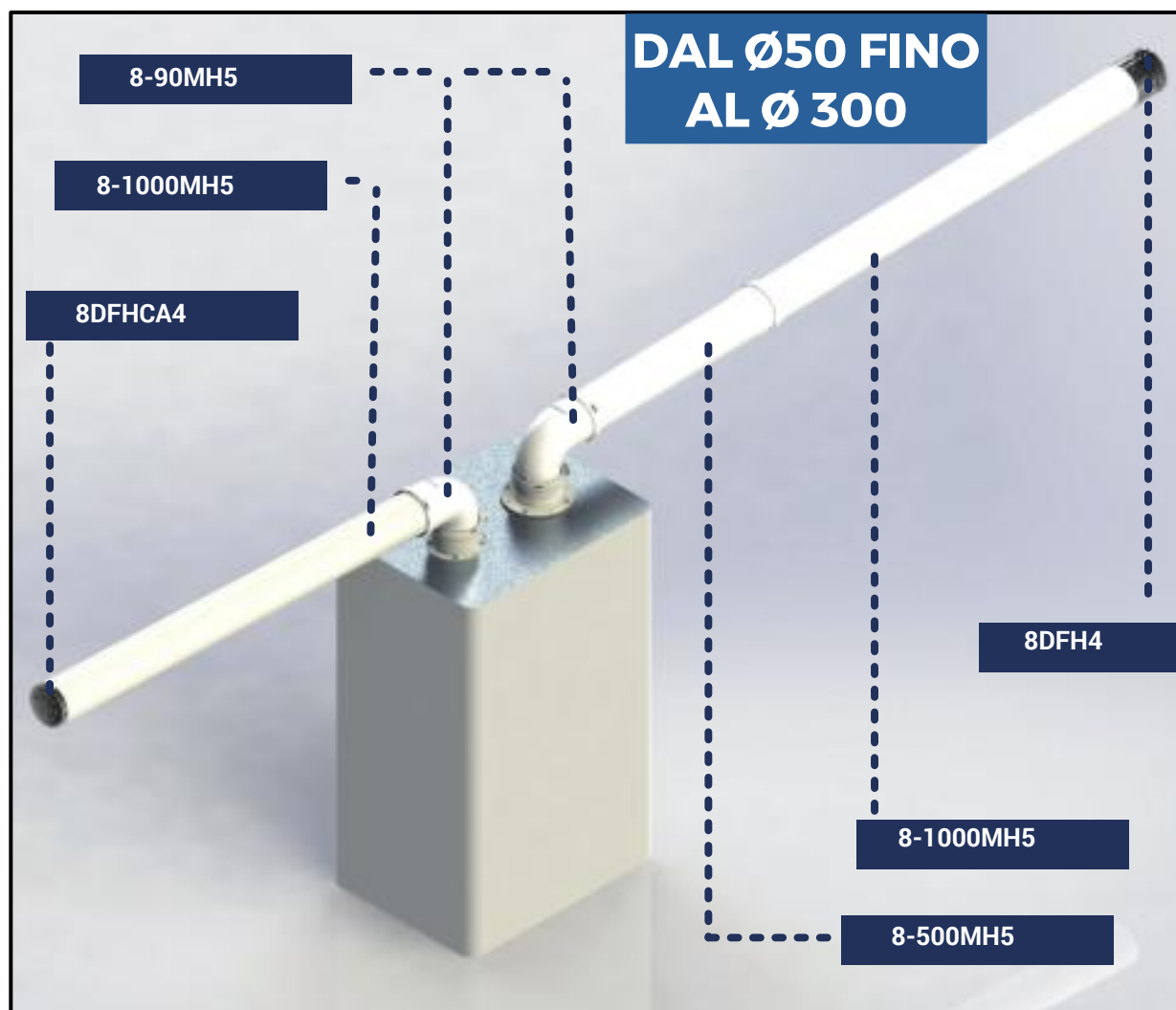

IMMAGINE IMG	DESCRIZIONE DESCRIPTION	SPECIFICHE SPECIFICATIONS	CODICE PART NUMBER	DIAMETRO DIAMETER	PZ per SCA PCS per BOX	PREZZO LISTINO LIST PRICE (€)		
	Prolunghe Extensions	Polipropilene bianco White polypropylene	5-250MH5	Ø50 - L=250	20	5,05		
			5-500MH5	Ø50 - L=500	10	6,02		
	Maschio/Femmina Male/Female	Guarnizione in EPDM EPDM seals	5-1000MH5	Ø50 - L=1000	10	9,14		
			5-2000MH5	Ø50 - L=2000	12	17,33		
			6-250MH5-S	Ø60 - L=250	1	4,33		
			6-500MH5-S	Ø60 - L=500	1	5,77		
			6-1000MH5-S	Ø60 - L=1000	1	8,37		
			6-2000MH5-S	Ø60 - L=2000	1 20*	16,55		
			8-250MH5-S	Ø80 - L=250	1	5,31		
			8-500MH5-S	Ø80 - L=500	1	6,19		
			8-1000MH5-S	Ø80 - L=1000	1	8,97		
			8-2000MH5-S	Ø80 - L=2000	1 60*	17,80		
			10-250MH5	Ø100 - L=250	1	9,17		
			10-500MH5	Ø100 - L=500	1	13,25		
			10-1000MH5	Ø100 - L=1000	1	15,54		
			10-2000MH5	Ø100 - L=2000	1	31,79		
			11-250MH5	Ø110 - L=250	1	14,75		
			11-500MH5	Ø110 - L=500	1	15,45		
			11-1000MH5	Ø110 - L=1000	1	25,70		
			11-2000MH5	Ø110 - L=2000	1	38,84		
			125-250MH5	Ø125 - L=250	1	12,65		
			125-500MH5	Ø125 - L=500	1	19,16		
			125-1000MH5	Ø125 - L=1000	1	23,17		
			125-2000MH5	Ø125 - L=2000	1	46,34		
			160-250MH5	Ø160 - L=250	1	27,70		
			160-500MH5	Ø160 - L=500	1	29,85		
			160-1000MH5	Ø160 - L=1000	1	44,54		
			160-2000MH5	Ø160 - L=2000	1	72,87		
			200-500MH5	Ø200 - L=500	1	40,92		
			200-1000MH5	Ø200 - L=1000	1	55,38		
	200-2000MH5	Ø200 - L=2000	1	106,10				
	250-500MH5	Ø250 - L=500	1	110,75				
	250-1000MH5	Ø250 - L=1000	1	131,42				
250-2000MH5	Ø250 - L=2000	1	178,65					
300-500MH5 *	Ø300 - L=500	1	125,20					
300-1000MH5 *	Ø300 - L=1000	1	147,36					
300-2000MH5 *	Ø300 - L=2000	1	192,99					
* Chiedere disponibilità * Ask for availability						* Quantità per scatola completa		
	Prolunghe Extensions	Polipropilene bianco White polypropylene	6-250MH5-SNT	Ø60 - L=250	1 (kit 40 pz)	106,08		
			6-500MH5-SNT	Ø60 - L=500	1 (kit 60 pz)	245,44		
	Maschio/Femmina Male/Female	Guarnizione in EPDM MONTATA EPDM seal - mounted	6-1000MH5-SNT	Ø60 - L=1000	1 (kit 50 pz)	346,00		
			6-2000MH5-SNT	Ø60 - L=2000	1 (kit 20 pz)	280,80		
	Articolo NON termoretrato This article is NOT (heat) shrink-wrapped	ARTICOLO NON VENDIBILE SINGOLARMENTE THIS ITEM CANNOT BE SOLD INDIVIDUALLY	8-250MH5-SNT	Ø80 - L=250	1 (kit 40 pz)	182,98		
			8-500MH5-SNT	Ø80 - L=500	1 (kit 60 pz)	303,36		
			8-1000MH5-SNT	Ø80 - L=1000	1 (kit 60 pz)	468,00		
			8-2000MH5-SNT	Ø80 - L=2000	1 (kit 60 pz)	910,08		
			ARTICOLO NON VENDIBILE SINGOLARMENTE THIS ITEM CANNOT BE SOLD INDIVIDUALLY					
			ARTICOLO NON VENDIBILE SINGOLARMENTE THIS ITEM CANNOT BE SOLD INDIVIDUALLY					
	Curve 15° Elbow 15°	Polipropilene bianco White polypropylene	6-15MH5 *	Ø60	1	39,97		
			8-15MH5 *	Ø80	1	46,05		
Maschio/Femmina Male/Female	Guarnizione in EPDM EPDM seals							
	Curve 30° Elbow 30°	Polipropilene bianco White polypropylene	6-30MH5 *	Ø60	1	39,97		
			8-30MH5 *	Ø80	1	46,05		
			10-30MH5 *	Ø100	1	48,66		
			125-30MH5 *	Ø125	1	51,52		
			160-30MH5 *	Ø160	1	62,36		
			200-30MH5 *	Ø200	1	93,41		
Maschio/Femmina Male/Female		Guarnizione in EPDM EPDM seals						
* Chiedere disponibilità * Ask for availability								

IMMAGINE IMG	DESCRIZIONE DESCRIPTION	SPECIFICHE SPECIFICATIONS	CODICE PART NUMBER	DIAMETRO DIAMETER	MINIMO ORD MIN. ORD QTY	PREZZO LISTINO LIST PRICE (€)
	Curve 45° Elbow 45° Maschio/Femmina Male/Female * Chiedere disponibilità * Ask for availability	Polipropilene bianco White polypropylene Guarnizione in EPDM EPDM seals	5-45MH5	Ø50	10	4,92
			6-45MH5-S	Ø60	1	4,34
			8-45MH5-S	Ø80	1	4,58
			10-45MH5	Ø100	1	9,05
			11-45MH5	Ø110	1	16,49
			125-45MH5	Ø125	1	19,15
			160-45MH5	Ø160	1	33,11
			200-45MH5	Ø200	1	42,46
			250-45MH5	Ø250	1	81,44
300-45MH5 *	Ø300	1	112,28			
	Curve 45° Elbow 45° Maschio/Femmina Male/Female Articolo NON termoretrato This article is NOT (heat) shrink-wrapped	Polipropilene bianco White polypropylene Guarnizione in EPDM MONTATA EPDM seal - mounted	6-45MH5-SNT	Ø60	1 (kit 30 pz)	111,49
			8-45MH5-SNT	Ø80	1 (kit 30 pz)	122,78
			KIT 30 PEZZI ARTICOLO NON VENDIBILE SINGOLARMENTE 30 PCS KIT THIS ITEM CANNOT BE SOLD INDIVIDUALLY			
	Curve 90° Elbow 90° Maschio/Femmina Male/Female * Chiedere disponibilità * Ask for availability	Polipropilene bianco White polypropylene Guarnizione in EPDM EPDM seals	5-90MH5	Ø50	10	4,92
			6-90MH5-S	Ø60	1	4,53
			8-90MH5-S	Ø80	1	4,58
			10-90MH5	Ø100	1	9,60
			11-90MH5	Ø110	1	14,81
			125-90MH5	Ø125	1	20,47
			160-90MH5	Ø160	1	33,03
			200-90MH5	Ø200	1	56,10
			250-90MH5	Ø250	1	96,54
300-90MH5 *	Ø300	1	144,94			
	Curve 90° Elbow 90° Maschio/Femmina Male/Female Articolo NON termoretrato This article is NOT (heat) shrink-wrapped	Polipropilene bianco White polypropylene Guarnizione in EPDM MONTATA EPDM seal - mounted	6-90MH5-SNT	Ø60	1 (kit 50 pz)	176,38
			8-90MH5-SNT	Ø80	1 (kit 50 pz)	210,67
			KIT 50 PEZZI ARTICOLO NON VENDIBILE SINGOLARMENTE 50 PCS KIT THIS ITEM CANNOT BE SOLD INDIVIDUALLY			
	Tee con tappo raccoglicondensa Tee with condensing drain cap Maschio/maschio/femmina Male/male/female	Polipropilene bianco White polypropylene Guarnizione in EPDM EPDM seals	5TES	Ø50	1	34,00
			6TES	Ø60	1	14,80
			8TES	Ø80	1	15,60
			10TES	Ø100	1	28,00
			11TES	Ø110	1	60,67
			125TES	Ø125	1	32,00
			160TES	Ø160	1	88,12
			200TES	Ø200	1	103,20
			250TES	Ø250	1	161,92
			300TES	Ø300	1	260,03
	Tee senza tappo Tee without cap Maschio/maschio/femmina Male/male/female * Chiedere disponibilità * Ask for availability	Polipropilene bianco White polypropylene Guarnizione in EPDM EPDM seals	5TES-ST	Ø50	1	24,60
			6TES-ST	Ø60	1	10,00
			8TES-ST	Ø80	1	10,00
			10TES-ST	Ø100	1	15,20
			11TES-ST	Ø110	1	42,76
			125TES-ST	Ø125	1	18,00
			160TES-ST	Ø160	1	67,93
			200TES-ST	Ø200	1	79,26
			250TES-ST	Ø250	1	197,42
			300TES-ST *	Ø300	1	202,24
	Tappo raccoglicondensa verticale Vertical condensing drain cap Femmina Female * Chiedere disponibilità * Ask for availability	Polipropilene bianco White polypropylene Guarnizione in EPDM EPDM seals	5TAPES	Ø50	1	12,00
			6TAPES	Ø60	1	7,20
			8TAPES	Ø80	1	7,60
			10TAPES	Ø100	1	13,10
			11TAPES	Ø110	1	19,26
			125TAPES	Ø125	1	16,80
			160TAPES	Ø160	1	28,89
			200TAPES	Ø200	1	37,55
			250TAPES	Ø250	1	46,09
			300TAPES *	Ø300	1	49,48



IMMAGINE IMG	DESCRIZIONE DESCRIPTION	SPECIFICHE SPECIFICATIONS	CODICE PART NUMBER	DIAMETRO DIAMETER	PZ per SCA PCS per BOX	PREZZO LISTINO LIST PRICE (€)
	Tappo cieco verticale/orizzontale <i>Vertical/horizontal blind cap</i> Femmina <i>Female</i> * Chiedere disponibilità * Ask for availability	Polipropilene bianco <i>White polypropylene</i> Guarnizione in EPDM <i>EPDM seal</i>	6TAPPOC5	Ø60	1	16,61
			8TAPPOC5	Ø80	1	7,03
			10TAPPOC5	Ø100	1	18,91
			125TAPPOC5	Ø125	1	21,91
			160TAPPOC5 *	Ø160	1	31,29
	Tappo raccoglicondensa orizzontale <i>Horizontal condensing drain cap</i> Femmina <i>Female</i> * Chiedere disponibilità * Ask for availability	Gomma EPDM <i>EPDM Rubber</i> Fascetta in acciaio zincato <i>Gavanized teel clamp</i>	125TAPECONDENSA	Ø125	1	22,63
			160TAPECONDENSA	Ø160	1	29,47
			200TAPECONDENSA	Ø200	1	36,84
			250TAPECONDENSA	Ø250	1	40,53
			300TAPECONDENSA *	Ø300	1	48,45
	Tee con mensola di supporto <i>Tee adapter with support bracket</i> Maschio/maschio/femmina <i>Male/male/female</i> * Chiedere disponibilità * Ask for availability	Polipropilene bianco <i>White polypropylene</i> Guarnizione in EPDM <i>EPDM seals</i>	6TESOPORTE5 *	Ø60	1	43,76
			8TESOPORTE5 *	Ø80	1	43,76
			10TESOPORTE5 *	Ø100	1	50,87
	Curva 90° con mensola di supporto <i>90° elbow with support bracket</i> Maschio/femmina <i>Male/female</i> * Chiedere disponibilità * Ask for availability	Polipropilene bianco <i>White polypropylene</i> Guarnizione in EPDM <i>EPDM seals</i>	5CODOSOPORTE5	Ø50	1	48,76
			6CODOSOPORTE5	Ø60	1	42,13
			8CODOSOPORTE5	Ø80	1	42,52
			10CODOSOPORTE5	Ø100	1	45,74
			125CODOSOPORTE5 *	Ø125	1	69,22
			160CODOSOPORTE5 *	Ø160	1	78,55
200CODOSOPORTE5 *	Ø200	1	85,71			

TERMINALI/GRIGLIE - TERMINALS/GRIDS

IMMAGINE IMG	DESCRIZIONE DESCRIPTION	SPECIFICHE SPECIFICATIONS	CODICE PART NUMBER	DIAMETRO DIAMETER	MINIMO ORD MIN ORD.QTY	PREZZO LISTINO LIST PRICE (€)
	Griglia scarico fumi verticale <i>Vertical grid for flue gas exit</i> Femmina <i>Female</i>	Inox 304 <i>Stainless steel</i>	6DFV4	Ø60	10	17,62
			8DFV4	Ø80	10	16,85
			10DFV4	Ø100	10	21,91
			125DFV4	Ø125	1	55,04
	Griglia scarico fumi orizzontale <i>Horizontal grid for flue gas exit</i> Femmina <i>Female</i>	Inox 304 <i>Stainless steel</i>	6DFH4	Ø60	10	7,58
			8DFH4	Ø80	10	7,77
			10DFH4	Ø100	10	13,06
	Griglia scarico fumi orizzontale <i>Horizontal grid for flue gas exit</i> Maschio <i>Male</i>	Inox 304 e polipropilene bianco <i>Stainless steel and white polypropylene</i> <small>Riduzione Ø60/50 F-M + griglia Ø60 montata Reduction Ø60/50 F-M + mounted Ø60 grid</small>	5DFH4	Ø50	10	12,03
	Griglia aspirazione orizzontale con parapiovvia <i>Horizontal grid with rain cover</i> <i>Air inlet</i> Femmina <i>Female</i>	Inox 304 <i>Stainless steel</i>	5DFHALL4	Ø50	10	15,20
			6DFHALL4	Ø60	10	14,63
			8DFHALL4	Ø80	10	15,70
	Griglia aspirazione orizzontale <i>Horizontal grid - Air inlet</i> Femmina <i>Female</i>	Inox 304 <i>Stainless steel</i>	5DFHCAL4	Ø50	10	7,96
			6DFHCAL4	Ø60	10	7,22
			8DFHCAL4	Ø80	10	7,71

TERMINALI/GRIGLIE - TERMINALS/GRIDS

IMMAGINE IMG	DESCRIZIONE DESCRIPTION	SPECIFICHE SPECIFICATIONS	CODICE PART NUMBER	DIAMETRO DIAMETER	MINIMO ORD MIN ORD.QTY	PREZZO LISTINO LIST PRICE (€)
	Griglia aspirazione orizzontale Horizontal grid - Air inlet Femmina Female	Inox 304 Stainless steel	6DFHTA4	Ø60	10	9,05
			8DFHTA4	Ø80	10	11,23
			10DFHTA4	Ø100	10	14,09
	Griglia aspirazione orizzontale Horizontal grid - Air inlet Femmina Female	Inox 304 Stainless steel	6DFHCA4	Ø60	10	5,64
			8DFHCA4	Ø80	10	6,51
	Griglia aspirazione orizzontale Horizontal grid - Air inlet Femmina Female	Polipropilene grigio Grey polypropylene RESISTENTE AI RAGGI U.V. U.V. RESISTANT	8DFH7	Ø80	10	3,48
	Griglia scarico fumi orizzontale Horizontal grid for flue gas exit Femmina Female	Polipropilene nero Black polypropylene RESISTENTE AI RAGGI U.V. U.V. RESISTANT	6DFH5	Ø60	10	4,82
	Griglia scarico fumi orizzontale Horizontal grid for flue gas exit Femmina Female	Polipropilene nero Black polypropylene RESISTENTE AI RAGGI U.V. U.V. RESISTANT	8DFH5	Ø80	10	4,14
	Griglia orientabile Adjustable grid Femmina Female	Polipropilene nero Black polypropylene RESISTENTE AI RAGGI U.V. U.V. RESISTANT	610DFORIENT5 *	Ø60 - 60/100	1	18,96
	Griglia a becco anti intrusione 30° cut anti intrusion grid Maschio Male	Polipropilene nero Black polypropylene RESISTENTE AI RAGGI U.V. U.V. RESISTANT	5DFHALL5	Ø50	1	10,94
			6DFHALL5	Ø60	1	15,11
			8DFHALL5	Ø80	1	15,82
			10DFHALL5	Ø100	1	19,13
			125DFHALL5 *	Ø125	1	25,60
160DFHALL5 *	Ø160	1	56,80			
	Griglia a becco anti intrusione 30° cut anti intrusion grid Maschio Male	Polipropilene bianco White polypropylene RESISTENTE AI RAGGI U.V. U.V. RESISTANT	11DFHALL5-B *	Ø110	1	20,23
			125DFHALL5-B *	Ø125	1	25,60
			160DFHALL5-B *	Ø160	1	56,80
			200DFHALL5-B *	Ø200	1	65,41
	Camino Vertical terminal Maschio Male	Polipropilene nero Black polypropylene RESISTENTE AI RAGGI U.V. U.V. RESISTANT	8ST58 + 58AMPMH5*	Ø50	1	84,27 + 26,48
			8ST58 + 68AMPMH5*	Ø60	1	84,27 + 8,75
			8ST58	Ø80	1	84,27
			10ST58	Ø100	1	100,64
			125ST58	Ø125	1	120,38
			160ST58	Ø160	1	81,53
			8ST58-R	Ø80	1	Su richiesta On request
*Per diametri più piccoli abbinare riduzioni al codice 8ST58			Colore rosso - Red brick color			
	Griglia Antigoccia Anti-Downdraught grid Maschio Male	Polipropilene nero Black polypropylene RESISTENTE AI RAGGI U.V. U.V. RESISTANT	6DFANTIGOTE05	Ø60	1	8,67
			8DFANTIGOTE05	Ø80	1	8,67

RIDUZIONI ED INCREMENTI - REDUCERS AND INCREASERS

IMMAGINE IMG	DESCRIZIONE DESCRIPTION	SPECIFICHE SPECIFICATIONS	CODICE PART NUMBER	DIAMETRO DIAMETER	PZ per SCA PCS per BOX	PREZZO LISTINO LIST PRICE (€)
	Riduzioni ed incrementi asimmetrici <i>Asymmetric reducers and increasers</i> Applicazioni orizzontali <i>Horizontal application</i> Maschio/Femmina <i>Male/Female</i>	Polipropilene bianco <i>White polypropylene</i> Guarnizione in EPDM <i>EPDM seals</i>	68AMPASIMH5	M 60 / F 80	1	25,62
			810AMPASIMH5	M 80 / F 100	1	28,10
			811AMPASIMH5	M 80 / F 110	1	30,10
			10125AMPASIMH5	M 100 / F 125	1	35,34
			125160AMPASIMH5	M 125 / F 160	1	62,85
			160200AMPASIMH5	M 160 / F 200	1	73,96
			200250AMPASIMH5	M 200 / F 250	1	97,33
	Riduzioni ed incrementi <i>Reducers and increasers</i> Applicazioni verticali <i>Vertical application</i> Maschio/Femmina <i>Male/Female</i>	Polipropilene nero <i>Black polypropylene</i> Guarnizione in EPDM <i>EPDM seals</i>	56AMPMH5NERA	M 50 / F 60	1	28,86
			65REDMH5NERA	M 60 / F 50	1	20,90
			68AMPMH5NERA	M 60 / F 80	1	9,54
			86REDMH5NERA	M 80 / F 60	1	12,00

RACCOGLI CONDENSA E ISPEZIONI - CONDENSING TRAPS AND TESTING POINTS

IMMAGINE IMG	DESCRIZIONE DESCRIPTION	SPECIFICHE SPECIFICATIONS	CODICE PART NUMBER	DIAMETRO DIAMETER	PZ per SCA PCS per BOX	PREZZO LISTINO LIST PRICE (€)
	Tronchetto raccogli condensa <i>Condensing trap</i> Maschio/femmina <i>Male/female</i> Applicazioni orizzontali e verticali <i>Horizontal and vertical application</i>	Polipropilene bianco <i>White polypropylene</i> Guarnizione in EPDM <i>EPDM seals</i>	8RCMH5	Ø80	1	34,12
	Tronchetto con ispezione <i>Adapter with testing point</i> Maschio/femmina <i>Male/female</i> * Chiedere disponibilità * Ask for availability	Polipropilene bianco <i>White polypropylene</i> Guarnizione in EPDM <i>EPDM seals</i>	6TM5	Ø60	1	17,48
			8TM5	Ø80	1	17,63
			10TM5	Ø100	1	21,15
			125TM5 *	Ø125	1	29,10
			160TM5 *	Ø160	1	54,22
			200TM5 *	Ø200	1	61,64
	Curva 90° con ispezione visiva <i>90° Elbow with inspection window</i> Maschio/femmina <i>Male/female</i> * Chiedere disponibilità * Ask for availability	Polipropilene bianco <i>White polypropylene</i> Guarnizione in EPDM <i>EPDM seals</i>	6-90IV5	Ø60	1	19,26
			8-90IV5	Ø80	1	20,47
			10-90IV5	Ø100	1	35,21
			11-90IV5	Ø110	1	38,52
			125-90IV5	Ø125	1	43,34
			160-90IV5	Ø160	1	57,79
			200-90IV5	Ø200	1	67,41
			250-90IV5 *	Ø250	1	126,40
			300-90IV5 *	Ø300	1	139,05

RACCOGLI CONDENSA ED ISPEZIONI CONDENSING TRAPS AND TESTING POINTS

IMMAGINE IMG	DESCRIZIONE DESCRIPTION	SPECIFICHE SPECIFICATIONS	CODICE PART NUMBER	DIAMETRO DIAMETER	PZ per SCA PCS per BOX	PREZZO LISTINO LIST PRICE (€)
	Tronchetto con ispezione visiva <i>Extension with inspection</i> Maschio/Femmina <i>Male/Female</i> * Chiedere disponibilità * Ask for availability	Polipropilene bianco <i>White polypropylene</i> Guarnizione in EPDM <i>EPDM seals</i>	6IV5	Ø60	1	28,65
			8IV5	Ø80	1	38,52
			10IV5	Ø100	1	48,16
			125IV5	Ø125	1	50,56
			160IV5	Ø160	1	58,99
			200IV5 *	Ø200	1	67,41
			250IV5 *	Ø250	1	93,40





COLLETTORI E VALVOLE CLAPET - FLUE MANIFOLD AND CLAPET VALVES

IMMAGINE IMG	DESCRIZIONE DESCRIPTION	SPECIFICHE SPECIFICATIONS	CODICE PART NUMBER	DIAMETRO DIAMETER	PZ per SCA PCS per BOX	PREZZO LISTINO LIST PRICE (€)
	Collettore orizzontale con raccordo a 90° <i>Horizontal flue manifold with 90° elbow</i> Maschio/maschio/femmina <i>Male/male/female</i>	Polipropilene bianco <i>White polypropylene</i> Guarnizione in EPDM <i>EPDM seals</i> Chiedere disponibilità <i>Ask for availability</i>	100125COLCODYTUB5	Ø 100 / 125	1	144,46
			100160COLCODYTUB5	Ø 100 / 160	1	148,31
			100200COLCODYTUB5	Ø 100 / 200	1	152,54
			100250COLCODYTUB5	Ø 100 / 250	1	154,91
			100300COLCODYTUB5	Ø 100 / 300	1	179,67
	Collettore verticale con raccordo a 90° <i>Vertical flue manifold with 90° elbow</i> Maschio/maschio/femmina <i>Male/male/female</i>	Polipropilene bianco <i>White polypropylene</i> Guarnizione in EPDM <i>EPDM seals</i> * Chiedere disponibilità * Ask for availability	68COLVERT5 *	Ø 60/80	1	38,77
			610COLVERT5	Ø 60/100	1	46,59
			6125COLVERT5	Ø 60/125	1	53,80
			810COLVERT5	Ø 80/100	1	40,92
			8125COLVERT5	Ø 80/125	1	52,98
			8160COLVERT5	Ø 80/160	1	55,38
			8200COLVERT5 *	Ø 80/200	1	74,21
			8250COLVERT5	Ø 80/250	1	89,56
			8300COLVERT5 *	Ø 80/300	1	102,33
			100125COLVERT5	Ø 100/125	1	63,38
			100160COLVERT5	Ø 100/160	1	57,40
100200COLVERT5	Ø 100/200	1	96,31			
160200COLVERT5 *	Ø 160/200	1	148,00			
	Valvola clapet telescopica <i>Telescopic clapet valve</i> Applicazioni verticali <i>Vertical application</i> Maschio/Femmina <i>Male/Female</i>	Polipropilene bianco <i>White polypropylene</i> Guarnizione in EPDM <i>EPDM seals</i>	8CCVAREG5	M 80 / F 100	1	73,67
			10CCVAREG5	M 100 / F 100	1	76,14
	Valvola clapet <i>Clapet valve</i> Applicazioni verticali e orizzontali <i>Vertical and horizontal application</i> Maschio/Femmina <i>Male/Female</i>	Polipropilene bianco <i>White polypropylene</i> Guarnizione in EPDM <i>EPDM seals</i>	8VALVULAHOR5	Ø80	1	31,42
	Manicotto femmina/femmina <i>Female/Female adapter</i>	Polipropilene bianco <i>White polypropylene</i> Guarnizione in EPDM <i>EPDM seals</i>	6MTT5	Ø60 - L=220	1	13,02
			8MTT5	Ø80 - L=220	1	14,63

ACCESSORI - ACCESSORIES

IMMAGINE IMG	DESCRIZIONE DESCRIPTION	SPECIFICHE SPECIFICATIONS	CODICE PART NUMBER	DIAMETRO DIAMETER	PZ per SCA PCS per BOX	PREZZO LISTINO LIST PRICE (€)
	Rosone per installazione esterna Wall plate for external installation	EPDM bianco White EPDM * Realizzato in PP * Made in PP	5PL6 *	Ø50	10	3,86
			6PL6	Ø60	10	2,16
			8PL6	Ø80	10	2,16
			10PL6	Ø100	10	2,53
			125PL6	Ø125	10	7,25
	Rosone per installazione interna Wall plate for internal installation	Ø80 - Chemiton Ø100 - Ø125 - Polyethylene Bianco White	8PL6-INT	Ø80	10	2,16
			10PL6-INT	Ø100	10	3,12
			125PL6-INT	Ø125	10	7,25
	Rosone per installazione esterna Wall plate for external installation	EPDM grigio Grey EPDM	6PL6-G	Ø60	10	2,16
			10PL6-G	Ø100	10	2,53
			125PL6-G	Ø125	10	7,25
	Rosone per installazione esterna Wall plate for external installation RESISTENTE AI RAGGI U.V. U.V. RESISTANT	EPDM nero Black EPDM	6PL6-NERO	Ø60	10	2,16
			8PL6-NERO	Ø80	10	2,30
			10PL6-NERO	Ø100	10	4,33
			125PL6-NERO	Ø125	10	8,25
	Collare a parete Wall clamp	Acciaio verniciato bianco White coated steel	6ABSOPORTMURO	Ø60	1	9,43
			8ABSOPORTMURO	Ø80	1	9,87
			10ABSOPORTMURO	Ø100	1	14,51
	Collare per supporto orizzontale Horizontal support bracket	Acciaio zincato Galvanized steel	SOPORTEHOR250	Da Ø50 a Ø 160	1	27,41
	Collare di serraggio Locking collar	Acciaio zincato Galvanized steel	5ABSOPORTFLEX	Ø50	1	10,73
			6ABSOPORTFLEX	Ø60	1	9,76
			8ABSOPORTFLEX	Ø80	1	9,86
			10ABSOPORTFLEX	Ø100	1	10,62
			125ABSOPORTFLEX	Ø125	1	13,54
			160ABSOPORTFLEX	Ø160	1	21,90
			200ABSOPORTFLEX	Ø200	1	28,80
250ABSOPORTFLEX	Ø250	1	36,86			
	Collare a parete Wall clamp	Acciaio verniciato bianco White coated steel * Non verniciati * Unpainted	5ABPRP3	Ø50	10	3,83
			6ABPRP3	Ø60	10	4,19
			8ABPRP3	Ø80	10	4,60
			10ABPRP3	Ø100	10	5,57
			11ABPRP3	Ø110	10	6,74
			125ABPRP3	Ø125	10	6,86
			150ABPRP3 *	Ø150	10	11,38
			160ABPRP3 *	Ø160	10	14,75
			200ABPRP3 *	Ø200	10	15,41
250ABPRP3 *	Ø250	10	17,61			







ACCESSORI - ACCESSORIES

IMMAGINE IMG	DESCRIZIONE DESCRIPTION	SPECIFICHE SPECIFICATIONS	CODICE PART NUMBER	DIAMETRO DIAMETER	PZ per SCA PCS per BOX	PREZZO LISTINO LIST PRICE (€)
	Sifone Syphon Per installazione verticale/ orizzontale For vertical/horizontal installation	Polipropilene Polypropylene	SIFON5	-	1	19,13
			SIFONGR5	-	1	23,30
	Tubo estensibile per scarico sifone Extendable drain pipe for syphon Per installazione verticale/ orizzontale For vertical/horizontal installation	Polipropilene Polypropylene	SCARSIFONEST5	Ø18	100	3,61
	Lubrificante in tubetto monouso Lubricant grease tube single use	Privo di cloruro Clorid free	LUBRIMONO	2,5 ml	25	1,21
			LUBRIFIS	30 ml	10	3,62
			LUBRIFIBIG5	250 ml	10	8,93
	Guarnizione per linea condensazione Seal for condensing line	EPDM nero Black EPDM	5JT6	Ø50	10	2,91
			6JT6	Ø60	10	2,32
			8JT6	Ø80	10	2,91
			10JT6	Ø100	10	4,52
			11JT6	Ø110	10	4,52
			125JT6	Ø125	10	5,09
			160JT6	Ø160	10	5,53
			200JT6	Ø200	10	6,12
			250JT6	Ø250	10	6,61
300JT6	Ø300	10	7,25			

KIT INTUBAMENTO – KIT FOR "NARROW" MASONRY CHIMNEYS

IMMAGINE IMG	DESCRIZIONE DESCRIPTION	SPECIFICHE SPECIFICATIONS	CODICE PART NUMBER	DIAMETRO DIAMETER	PZ per SCA PCS per BOX	PREZZO LISTINO LIST PRICE (€)
	Kit intubamento canna fumaria stretta Kit for narrow masonry chimneys	Polipropilene bianco White polypropylene	6-90ROSCAMH5	Ø60 - 90°	1	22,11
			8-90ROSCAMH5	Ø80 - 90°	1	23,35
			86-90ROSCAMH5	Ø80F Ø60M - 90°	1	22,11
		Guarnizione in EPDM EPDM seals				

LINEA IN PPH NERO RESISTENTE AI RAGGI U.V. U.V. RESISTANT BLACK PPH LINE

IMMAGINE IMG	DESCRIZIONE DESCRIPTION	SPECIFICHE SPECIFICATIONS	CODICE PART NUMBER	DIAMETRO DIAMETER	PZ per SCA PCS per BOX	PREZZO LISTINO LIST PRICE (€)
	Tubo Flessibile <i>Flexible Pipe</i> Necessita adattatori <i>Adapters needed</i> Solo per installazioni verticali <i>For vertical installations only</i>	Polipropilene Nero <i>Black polypropylene</i>	5FLEXCONT5-NERO	Ø50 - 20 m	4	171,92
			5-50FLEXCONT5-NERO	Ø50 - 50 m	4	429,77
			6FLEXCONT5-NERO	Ø60 - 20 m	4	166,86
			6-50FLEXCONT5-NERO	Ø60 - 50 m	2	417,12
			8FLEXCONT5-NERO	Ø80 - 20 m	3	173,81
			8-50FLEXCONT5-NERO	Ø80 - 50 m	2	434,50
			10FLEXCONT5-NERO	Ø100 - 20 m	2	261,65
10-50FLEXCONT5-NERO	Ø100 - 50 m	2	654,12			
	Adattatori per tubo flessibile <i>Flexible pipe adapters</i> 1 Maschio e 1 Femmina <i>1 Male and 1 female</i>	Polipropilene Nero <i>Black polypropylene</i> Guarnizione in EPDM <i>EPDM seals</i>	5UNIONFLEX5-NERO	Ø50	1	11,95
			6UNIONFLEX5-NERO	Ø60	1	11,95
			8UNIONFLEX5-NERO	Ø80	1	13,08
			10UNIONFLEX5-NERO	Ø100	1	21,05
	Collare a parete <i>Wall clamp</i>	Acciaio verniciato nero <i>Black coated steel</i>	5ABPRPEL	50	1	4,98
			6ABPRPEL	60	1	5,72
			8ABPRPEL	80	1	7,15
			10ABPRPEL	100	1	8,20
			125ABPRPEL	125	1	9,00
	TE senza tappo <i>TEE adapter without cap</i>	Polipropilene nero <i>Black Polypropylene</i>	5TES-STNERA	Ø50	1	29,03
			6TES-STNERA	Ø60	1	13,00
			8TES-STNERA	Ø80	1	13,46
			10TES-STNERA	Ø100	1	15,96
			125TES-STNERA *	Ø125	1	21,80
			160TES-STNERA *	Ø160	1	74,73
	Tappo raccogli condensa verticale <i>Vertical condensing drain cap</i>	Polipropilene nero <i>Black EPDM</i>	5TAPESNERA	Ø50	1	14,16
			6TAPESNERA	Ø60	10	9,50
			8TAPESNERA	Ø80	10	9,80
			10TAPESNERA	Ø100	10	13,70
			125TAPESNERA *	Ø125	10	17,64
			160TAPESNERA *	Ø160	10	31,80
	Griglia a becco anti intrusione <i>30° cut anti intrusion grid</i>	Polipropilene nero <i>Black Polypropylene</i>	5DFHALL5	Ø50	1	10,94
			6DFHALL5	Ø60	1	15,11
			8DFHALL5	Ø80	1	15,82
			10DFHALL5	Ø100	1	19,13
			125DFHALL5	Ø125	1	25,60
			160DFHALL5 *	Ø160	1	56,80
	Rosone per installazione esterna <i>Wall plate for external installation</i>	EPDM nero <i>Black EPDM</i> Max temp: 120° C RESISTENTE AI RAGGI U.V. <i>U.V. RESISTANT</i>	6PL6-NERO	Ø60	10	2,16
			8PL6-NERO	Ø80	10	2,30
			10PL6-NERO	Ø100	10	4,33
			125PL6-NERO	Ø125	10	8,25

LINEA IN PPH NERO RESISTENTE AI RAGGI U.V.
U.V. RESISTANT BLACK PPH LINE

T120-HI-W-2-O-20-LE-E-U

IMMAGINE IMG	DESCRIZIONE DESCRIPTION	SPECIFICHE SPECIFICATIONS	CODICE PART NUMBER	DIAMETRO DIAMETER	PZ per SCA PCS per BOX	PREZZO LISTINO LIST PRICE (€)		
	Prolunghe <i>Extensions</i> Maschio/Femmina <i>Male/Female</i>	Polipropilene nero <i>Black polypropylene</i>	5-250MH5NERA	Ø50 - L=250	20	5,96		
			5-500MH5NERA	Ø50 - L=500	10	6,92		
			5-1000MH5NERA	Ø50 - L=1000	10	10,79		
			5-2000MH5NERA	Ø50 - L=2000	12	20,45		
			6-250MH5NERA	Ø60 - L=250	20	6,86		
			6-500MH5NERA	Ø60 - L=500	10	7,15		
			6-1000MH5NERA	Ø60 - L=1000	10	12,93		
			6-2000MH5NERA	Ø60 - L=2000	8	21,45		
			8-250MH5NERA	Ø80 - L=250	20	8,50		
			8-500MH5NERA	Ø80 - L=500	10	9,50		
		8-1000MH5NERA	Ø80 - L=1000	10	13,50			
		8-2000MH5NERA	Ø80 - L=2000	6	21,66			
		Guarnizione in EPDM <i>EPDM seals</i>	10-250MH5NERA	Ø100 - L=250	1	9,65		
			10-500MH5NERA	Ø100 - L=500	1	13,61		
			10-1000MH5NERA	Ø100 - L=1000	1	19,17		
			10-2000MH5NERA	Ø100 - L=2000	1	30,53		
			125-250MH5NERA	Ø125 - L=250	1	13,28		
			125-500MH5NERA	Ø125 - L=500	1	20,12		
			125-1000MH5NERA	Ø125 - L=1000	1	24,33		
			125-2000MH5NERA	Ø125 - L=2000	1	48,66		
160-250MH5NERA *	Ø605 - L=250		1	30,47				
160-500MH5NERA *	Ø160 - L=500		1	33,84				
160-1000MH5NERA *	Ø160 - L=1000	1	49,00					
160-2000MH5NERA *	Ø160 - L=2000	1	80,30					
	RESISTENTE AI RAGGI U.V. <i>U.V. RESISTANT</i>							
	Curve 90° <i>Elbow 90°</i> Maschio/Femmina <i>Male/Female</i>	Polipropilene nero <i>Black polypropylene</i> Guarnizione in EPDM <i>EPDM seals</i>	5-90MH5NERA	Ø50	1	5,40		
			6-90MH5NERA	Ø60	1	5,40		
			8-90MH5NERA	Ø80	1	5,45		
			10-90MH5NERA	Ø100	1	10,15		
			125-90MH5NERA *	Ø125	1	21,49		
			160-90MH5NERA *	Ø160	1	36,60		
	RESISTENTE AI RAGGI U.V. <i>U.V. RESISTANT</i>							
	Curve 45° <i>Elbow 45°</i> Maschio/Femmina <i>Male/Female</i>	Polipropilene nero <i>Black Polypropylene</i> Guarnizione in EPDM <i>EPDM seals</i>	5-45MH5NERA	Ø50	1	5,22		
			6-45MH5NERA	Ø60	1	5,22		
			8-45MH5NERA	Ø80	1	5,25		
			125-45MH5NERA	Ø100	1	9,52		
			125-45MH5NERA *	Ø125	1	20,11		
			160-45MH5NERA *	Ø160	1	36,42		
	RESISTENTE AI RAGGI U.V. <i>U.V. RESISTANT</i>							
	Prolunghe <i>Extensions</i> Maschio/Femmina <i>Male/Female</i>	Polipropilene Nero <i>Black polypropylene</i>	6-250MH5NERA-SNT	Ø60 - L=250	1 (kit 40 pz)	111,40		
			6-500MH5NERA-SNT	Ø60 - L=500	1 (kit 60 pz)	257,70		
			6-1000MH5NERA-SNT	Ø60 - L=1000	1 (kit 50 pz)	363,30		
			6-2000MH5NERA-SNT	Ø60 - L=2000	1 (kit 20 pz)	294,85		
			8-250MH5NERA-SNT	Ø80 - L=250	1 (kit 40 pz)	192,15		
			8-500MH5NERA-SNT	Ø80 - L=500	1 (kit 60 pz)	318,55		
			8-1000MH5NERA-SNT	Ø80 - L=1000	1 (kit 60 pz)	491,40		
			8-2000MH5NERA-SNT	Ø80 - L=2000	1 (kit 60 pz)	955,60		
			Articolo NON termoretrato <i>This article is NOT (heat) shrink-wrapped</i>	Guarnizione in EPDM <i>EPDM seal</i>	6-90MH5NERA-SNT	Ø60	1 (kit 50 pz)	185,20
					8-90MH5NERA-SNT	Ø80	1 (kit 50 pz)	221,20
		KIT 50 PEZZI ARTICOLO NON VENDIBILE SINGOLARMENTE 50 PCS KIT THIS ITEM CANNOT BE SOLD INDIVIDUALLY						
	Curve 90° <i>Elbow 90°</i> Maschio/Femmina <i>Male/Female</i>	Polipropilene Nero <i>Black polypropylene</i>	6-45MH5NERA-SNT	Ø60	1 (kit 30 pz)	117,05		
			8-45MH5NERA-SNT	Ø80	1 (kit 30 pz)	128,90		
			KIT 30 PEZZI ARTICOLO NON VENDIBILE SINGOLARMENTE 30 PCS KIT THIS ITEM CANNOT BE SOLD INDIVIDUALLY					
		KIT 30 PEZZI ARTICOLO NON VENDIBILE SINGOLARMENTE 30 PCS KIT THIS ITEM CANNOT BE SOLD INDIVIDUALLY						

Linea coassiale PP/Fe PER USO INTERNO / Only for internal use

T120-HI-W-2-O-00-LI-E-U0

IMMAGINE IMG	DESCRIZIONE DESCRIPTION	SPECIFICHE SPECIFICATIONS	CODICE PART NUMBER	DIAMETRO DIAMETER	PZ per SCA PCS per BOX	PREZZO LISTINO LIST PRICE (€)
	Prolunghe <i>Extensions</i> Maschio/Femmina <i>Male/Female</i> * Chiedere disponibilità * Ask for availability	Interno: Polipropilene bianco <i>Internal: White polypropylene</i> Esterno: Lamiera verniciata bianca <i>External: White coated steel</i> Guarnizione in EPDM <i>EPDM seals</i>	610-250MHP15	Ø60/100 - L=250	1	15,75
			610-500MHP15	Ø60/100 - L=500	1	19,68
			610-1000MHP15	Ø60/100 - L=1000	1	26,49
			610-2000MHP15	Ø60/100 - L=2000	1	73,13
			8125-250MHP15	Ø80/125 - L=250	1	21,15
			8125-500MHP15	Ø80/125 - L=500	1	23,75
			8125-1000MHP15	Ø80/125 - L=1000	1	37,18
			8125-2000MHP15	Ø80/125 - L=2000	1	73,13
			10150-250MHP15 *	Ø100/150 - L=250	1	37,01
			10150-500MHP15 *	Ø100/150 - L=500	1	44,23
10150-1000MHP15 *	Ø100/150 - L=1000	1	55,84			
10150-2000MHP15 *	Ø100/150 - L=2000	1	135,64			
	Curve 90° <i>Elbow 90°</i> Maschio/Femmina <i>Male/Female</i> * Chiedere disponibilità * Ask for availability	Interno: Polipropilene bianco <i>Internal: White polypropylene</i> Esterno: Lamiera verniciata bianca <i>External: White coated steel</i> Guarnizione in EPDM <i>EPDM seals</i>	610-90MHP15	Ø60/100	1	24,80
			8125-90MHP15	Ø80/125	1	34,92
			10150-90MHP15 *	Ø100/150	1	49,64
	Curve 45° <i>Elbow 45°</i> Maschio/Femmina <i>Male/Female</i> * Chiedere disponibilità * Ask for availability	Interno: Polipropilene bianco <i>Internal: White polypropylene</i> Esterno: Lamiera verniciata bianca <i>External: White coated steel</i> Guarnizione in EPDM <i>EPDM seals</i>	610-45MHP15	Ø60/100	1	23,63
			8125-45MHP15	Ø80/125	1	37,18
			10150-45MHP15 *	Ø100/150	1	52,24
	Curve 30° <i>Elbow 30°</i> Maschio/Femmina <i>Male/Female</i> * Chiedere disponibilità * Ask for availability	Interno: Polipropilene bianco <i>Internal: White polypropylene</i> Esterno: Lamiera verniciata bianca <i>External: White coated steel</i> Guarnizione in EPDM <i>EPDM seals</i>	610-30MHP15 *	Ø60/100	1	47,81
			8125-30MHP15 *	Ø80/125	1	52,49
	Curve 15° <i>Elbow 15°</i> Maschio/Femmina <i>Male/Female</i> * Chiedere disponibilità * Ask for availability	Interno: Polipropilene bianco <i>Internal: White polypropylene</i> Esterno: Lamiera verniciata bianca <i>External: White coated steel</i> Guarnizione in EPDM <i>EPDM seals</i>	610-15MHP15 *	Ø60/100	1	42,48
			8125-15MHP15 *	Ø80/125	1	42,48
	Curva 90° con mensola di supporto <i>90° elbow with support bracket</i> Maschio/femmina <i>Male/female</i> * Chiedere disponibilità * Ask for availability	Interno: Polipropilene bianco <i>Internal: White polypropylene</i> Esterno: Lamiera verniciata bianca <i>External: White coated steel</i> Guarnizione in EPDM <i>EPDM seals</i>	610CODOSOPORTES *	Ø60/100	1	63,78
			8125CODOSOPORTES *	Ø80/125	1	69,70
	Tronchetto con ispezione <i>Adapter with testing point</i> Maschio/femmina <i>Male/female</i> * Chiedere disponibilità * Ask for availability	Interno: Polipropilene bianco <i>Internal: White polypropylene</i> Esterno: Lamiera verniciata bianca <i>External: White coated steel</i> Guarnizione in EPDM <i>EPDM seals</i>	610TMMHP15 *	Ø60/100	1	49,99
			8125TMMHP15 *	Ø80/125	1	55,99
	Tee con tappo raccoglicondensa <i>Tee with condensing drain cap</i> Maschio/maschio/femmina <i>Male/male/female</i> * Chiedere disponibilità * Ask for availability	Interno: Polipropilene bianco <i>Internal: White polypropylene</i> Esterno: Lamiera verniciata bianca <i>External: White coated steel</i> Guarnizione in EPDM <i>EPDM seals</i>	610TEP15 *	Ø60/100	1	59,99
			8125TEP15 *	Ø80/125	1	89,97
			10150TEP15 *	Ø100/150	1	207,90

IMMAGINE IMG	DESCRIZIONE DESCRIPTION	SPECIFICHE SPECIFICATIONS	CODICE PART NUMBER	DIAMETRO DIAMETER	PZ per SCA PCS per BOX	PREZZO LISTINO LIST PRICE (€)
	Riduzioni ed incrementi <i>Reducers and increasers</i>	Interno: Polipropilene bianco <i>Internal: White polypropylene</i>	6810125AMPMPH15	da Ø60/100 a Ø80/125	1	24,18
			812510150AMPMPH15	da Ø80/125 a Ø100/150	1	74,97
	Applicazioni verticali <i>Vertical application</i>	Esterno: Lamiera verniciata bianca <i>External: White coated steel</i>				
	Maschio/Femmina <i>Male/Female</i>	Guarnizione in EPDM <i>EPDM seals</i>				
	Partenza branchiale <i>Starter kit adapter</i>	EPDM bianco <i>White EPDM</i>	610ENTRONASP15	da Ø60/100 a Ø80	1	29,00
	Installazione esterna <i>External installation</i>			From Ø60/100 to Ø80		

TERMINALI - TERMINALS

IMMAGINE IMG	DESCRIZIONE DESCRIPTION	SPECIFICHE SPECIFICATIONS	CODICE PART NUMBER	DIAMETRO DIAMETER	PZ per SCA PCS per BOX	PREZZO LISTINO LIST PRICE (€)
	Terminale orizzontale <i>Horizontal terminal</i>	Interno: Polipropilene bianco <i>Internal: White polypropylene</i>	610TDFHP15	Ø60/100	1	44,73
			8125TDFHP15	Ø80/125	1	52,45
			10150TDFHP15 *	Ø100/150	1	110,09
	Maschio/Femmina <i>Male/Female</i>	Esterno: Lamiera verniciata bianca <i>External: White coated steel</i>				
	* Chiedere disponibilità * Ask for availability	Guarnizione in EPDM <i>EPDM seals</i>				
	Griglia aspirazione/scarico <i>Air/flue grid</i>	Polipropilene bianco <i>White polypropylene</i>	610DFH57	Ø60/100	1	6,56
	Installazione orizzontale <i>Horizontal installation</i>	RESISTENTE AI RAGGI U.V. <i>U.V. RESISTANT</i>				
	Griglia aspirazione/scarico <i>Air/flue grid</i>	Polipropilene nero <i>Black polypropylene</i>	610DFH57-N	Ø60/100	1	6,56
			8125DFH57	Ø80/125	1	7,65
	Installazione orizzontale <i>Horizontal installation</i>	RESISTENTE AI RAGGI U.V. <i>U.V. RESISTANT</i>				
	Camino <i>Vertical terminal</i>	Polipropilene nero <i>Black polypropylene</i>	610ST58	Ø60 / 100	1	82,23
			8125ST58	Ø80 / 125	1	84,27
			10150ST58 *	Ø100 / 150	1	92,20
			610ST58-R *	Ø60 / 100	1	Su richiesta On request
			8125ST58-R *	Ø80 / 125	1	
	* Chiedere disponibilità * Ask for availability	RESISTENTE AI RAGGI U.V. <i>U.V. RESISTANT</i>				
						Colore rosso - Red brick color
	Camino <i>Vertical terminal</i>	Polipropilene nero <i>Black polypropylene</i>	610STNF58	Ø60 / 100	1	67,49
			8125STNF58	Ø80 / 125	1	95,60
	Maschio <i>Male</i>	RESISTENTE AI RAGGI U.V. <i>U.V. RESISTANT</i>				
		NO FROST <i>NO FROST</i>				
	Testata camino verticale <i>Chimney flue cap</i>	Polipropilene nero <i>Black Polypropylene</i>	610DFV58-V	Ø60/100	1	24,99
	Femmina <i>Female</i>	RESISTENTE AI RAGGI U.V. <i>U.V. RESISTANT</i>				

TERMINALI - TERMINALS

IMMAGINE IMG	DESCRIZIONE DESCRIPTION	SPECIFICHE SPECIFICATIONS	CODICE PART NUMBER	DIAMETRO DIAMETER	PZ per SCA PCS per BOX	PREZZO LISTINO LIST PRICE (€)
	Testata camino verticale <i>Chimney flue cap</i> Maschio <i>Male</i>	Polipropilene nero <i>Black polypropylene</i> RESISTENTE AI RAGGI U.V. <i>U.V. RESISTANT</i>	8125DFV58-V *	Ø80 / 125	1	56,86
	Testata camino <i>Terminal grid</i> No frost Maschio <i>Male</i>	Interno: Polipropilene bianco Esterno: Polipropilene nero <i>Internal: White polypropylene</i> <i>External: Black polypropylene</i> RESISTENTE AI RAGGI U.V. <i>U.V. RESISTANT</i>	610DFV58	Ø60 / 100	1	48,62
			8125DFV58	Ø80 / 125	1	56,86
	Tegola camino per tetti inclinati <i>Adjustable roof flashing</i>	Alluminio - gomma - nylon <i>Aluminium - rubber - nylon</i> RESISTENTE AI RAGGI U.V. <i>U.V. RESISTANT</i>	TEJA	da Ø60 a Ø125	1	39,73
			TEJA-R	da Ø60 a Ø125	1	Su richiesta <i>On request</i>
	Tegola camino per tetti piani <i>Flat roof flashing</i>	Nylon nero <i>Black nylon</i> RESISTENTE AI RAGGI U.V. <i>U.V. RESISTANT</i>	TEJAPLANA	da Ø60 a Ø125	1	23,12
			TEJAPLANA-R	da Ø60 a Ø125	1	Su richiesta <i>On request</i>

ACCESSORI - ACCESSORIES



IMMAGINE IMG	DESCRIZIONE DESCRIPTION	SPECIFICHE SPECIFICATIONS	CODICE PART NUMBER	DIAMETRO DIAMETER	PZ per SCA PCS per BOX	PREZZO LISTINO LIST PRICE (€)
	Wall plate for external installation	EPDM bianco <i>White EPDM</i>	10PL6	Ø100	10	2,53
			125PL6	Ø125	10	7,25
	Rosone per installazione interna <i>Wall plate for internal installation</i>	Ø80 - Chemiton Ø100 - Ø125 - Polyethylene Bianco <i>White</i>	10PL6-INT	Ø100	10	3,12
			125PL6-INT	Ø125	10	7,25
	Rosone per installazione esterna <i>Wall plate for external installation</i>	EPDM grigio <i>Grey EPDM</i>	10PL6-G	Ø100	10	2,53
			125PL6-G	Ø125	10	7,25
	Rosone per installazione In canna muraria <i>Wall plate for wall installation</i>	PP Bianco <i>White PP</i>	610PL5	Ø60/100	1	31,78
			8125PL5	Ø80/125	1	31,78
	Collare a parete <i>Wall clamp</i>	Acciaio verniciato bianco <i>White coated steel</i>	10ABSOPORTMURO	Ø100	1	14,51
	Collare per supporto orizzontale <i>Horizontal support bracket</i>	Acciaio zincato <i>Galvanized steel</i>	SOPORTEHOR250	Da Ø50 a Ø 160	1	27,41

ACCESSORI - ACCESSORIES

	Flangia Flange	Nylon Nylon	10BRIDAGIR8	Ø100	10	5,75
---	-------------------	----------------	-------------	------	----	------

T120-HI-W-2-O-00-LI-E-UI

LINEA PP/PP ANTI UV Ø60/100 – Ø60/100 COAXIAL PP/PP (no UV) LINE

IMMAGINE IMG	DESCRIZIONE DESCRIPTION	SPECIFICHE SPECIFICATIONS	CODICE PART NUMBER	DIAMETRO DIAMETER	PZ per SCA PCS per BOX	PREZZO LISTINO LIST PRICE (€)
	Prolunga coassiale Coaxial extension Polipropilene bianco White polypropylene	Ø60/100 Int: PP - Ext: PP	610-250MH55	Ø60/100	1	14,51
			610-500MH55	Ø60/100	1	19,64
			610-1000MH55	Ø60/100	1	23,85
			610-2000MH55	Ø60/100	1	39,44
	Curva coassiale 90° Coaxial elbow 90° Curva coassiale 45° Coaxial elbow 45° Polipropilene bianco White polypropylene	Ø60/100 Int: PP - Ext: PP	610-90MH55	Ø60/100	1	16,87
			610-45MH55	Ø60/100	1	16,87
	Terminale coassiale Coaxial terminal Polipropilene bianco White polypropylene	Ø60/100 Int: PP - Ext: PP	610TDFH58	Ø60/100	1	28,48

SISTEMA COIBENTATO PER CALDAIE A CONDENSAZIONE
INSULATED SYSTEM FOR CONDENSING BOILERS

**LINEA DOPPIA PARETE
COIBENTATA ARIA PER
APPLICAZIONI ESTERNE**

*DOUBLE WALL AIR
INSULATED SYSTEM FOR
EXTERNAL APPLICATION*

DIAMETRO INTERNO : POLIPROPILENE BIANCO
INTERNAL DIAMETER : WHITE POLYPROPYLENE

DIAMETRO ESTERNO : METALLO ZINCATO VERNICIATO
EXTERNAL WALL: GALVANIZED COATED STEEL

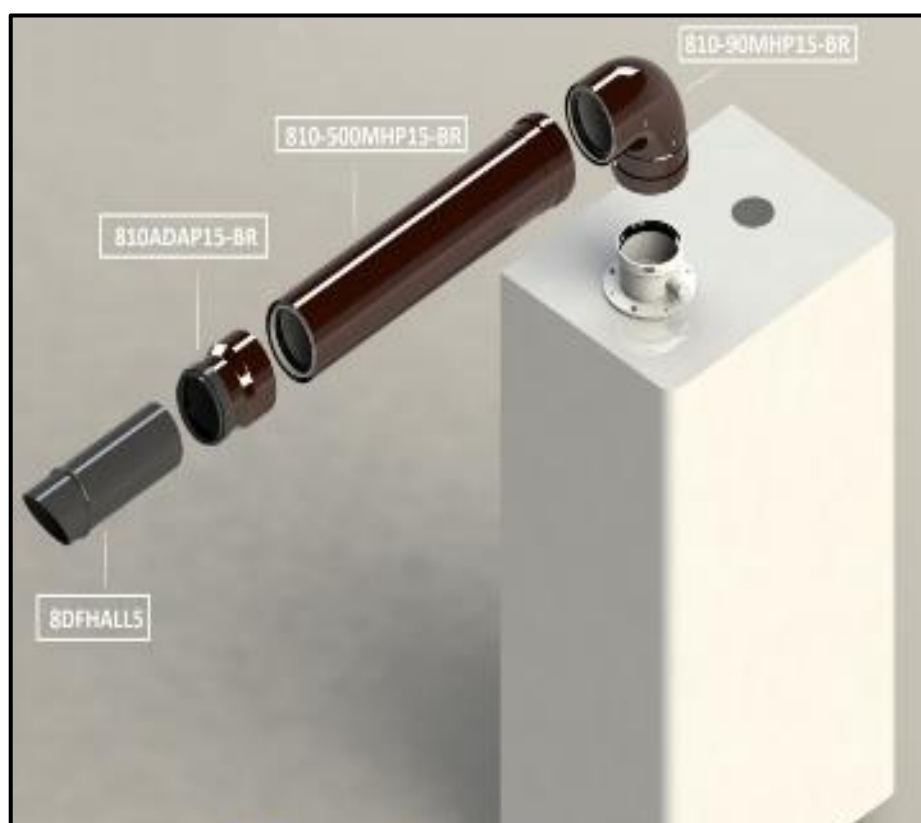

T120-H1-W-2-O-00-LI-E-U1

Colori disponibili - Available colors :

Bianco - White (Eurowhite)

Marrone - Brown (RAL 8019)

LINEA COLOR MARRONE – BROWN COLOR

IMMAGINE IMG	DESCRIZIONE DESCRIPTION	SPECIFICHE SPECIFICATIONS	CODICE PART NUMBER	DIAMETRO DIAMETER	PZ per SCA PCS per BOX	PREZZO LISTINO LIST PRICE (€)
	Prolunghe <i>Extensions</i> Maschio/Femmina <i>Male/Female</i>	Interno: Polipropilene bianco <i>Internal: White polypropylene</i> Esterno: Lamiera verniciata marrone <i>External: Brown coated steel</i> Guarnizione in EPDM <i>EPDM seals</i>	810-250MHP15-BR	Ø80/100 - L=250	1	31,49
			810-500MHP15-BR	Ø80/100 - L=500	1	34,87
			810-1000MHP15-BR	Ø80/100 - L=1000	1	43,86
	Curve 90° <i>Elbow 90°</i> Maschio/Femmina <i>Male/Female</i>	Interno: Polipropilene bianco <i>Internal: White polypropylene</i> Esterno: Lamiera verniciata marrone <i>External: Brown coated steel</i> Guarnizione in EPDM <i>EPDM seals</i>	810-90MHP15-BR	Ø80/100	1	36,22
	Curve 45° <i>Elbow 45°</i> Maschio/Femmina <i>Male/Female</i>	Interno: Polipropilene bianco <i>Internal: White polypropylene</i> Esterno: Lamiera verniciata marrone <i>External: Brown coated steel</i> Guarnizione in EPDM <i>EPDM seals</i>	810-45MHP15-BR	Ø80/100	1	34,92
	Tee con tappo raccoglicondensa <i>Tee with condensing drain cap</i> Maschio/maschio/femmina <i>Male/male/female</i>	Interno: Polipropilene bianco <i>Internal: White polypropylene</i> Esterno: Lamiera verniciata marrone <i>External: Brown coated steel</i> Guarnizione in EPDM <i>EPDM seals</i>	810TEP15-BR	Ø80/100	1	84,08
	Riduzioni ed incrementi <i>Reducers and increasers</i> Applicazioni verticali <i>Vertical application</i> Maschio/Femmina <i>Male/Female</i>	Interno: Polipropilene bianco <i>Internal: White polypropylene</i> Esterno: Lamiera verniciata marrone <i>External: Brown coated steel</i> Guarnizione in EPDM <i>EPDM seals</i>	810ADAP15-BR	Da Ø80/100 a Ø80	1	29,02
	Collare a parete <i>Wall clamp</i>	Acciaio verniciato marrone <i>Brown coated steel</i>	10ABPRP3-BR	Ø100	10	8,62

LINEA BIANCA – WHITE COLOR







IMMAGINE IMG	DESCRIZIONE DESCRIPTION	SPECIFICHE SPECIFICATIONS	CODICE PART NUMBER	DIAMETRO DIAMETER	PZ per SCA PCS per BOX	PREZZO LISTINO LIST PRICE (€)
	Prolunghe <i>Extensions</i> Maschio/Femmina <i>Male/Female</i>	Interno: Polipropilene bianco <i>Internal: White polypropylene</i> Esterno: Lamiera verniciata bianca <i>External: White coated steel</i> Guarnizione in EPDM <i>EPDM seals</i>	810-250MHP15	Ø80/100 - L=250	1	27,56
			810-500MHP15	Ø80/100 - L=500	1	30,37
			810-1000MHP15	Ø80/100 - L=1000	1	38,13
			810-2000MHP15	Ø80/100 - L=2000	1	88,85
	Curve 90° <i>Elbow 90°</i> Maschio/Femmina <i>Male/Female</i>	Interno: Polipropilene bianco <i>Internal: White polypropylene</i> Esterno: Lamiera verniciata bianca <i>External: White coated steel</i> Guarnizione in EPDM <i>EPDM seals</i>	810-90MHP15	Ø80/100	1	31,49
	Curve 45° <i>Elbow 45°</i> Maschio/Femmina <i>Male/Female</i>	Interno: Polipropilene bianco <i>Internal: White polypropylene</i> Esterno: Lamiera verniciata bianca <i>External: White coated steel</i> Guarnizione in EPDM <i>EPDM seals</i>	810-45MHP15	Ø80/100	1	30,37
	Tee con tappo raccoglicondensa <i>Tee with condensing drain cap</i> Maschio/maschio/femmina <i>Male/male/female</i>	Interno: Polipropilene bianco <i>Internal: White polypropylene</i> Esterno: Lamiera verniciata bianca <i>External: White coated steel</i> Guarnizione in EPDM <i>EPDM seals</i>	810TEP15	Ø80/100	1	73,10
	Riduzioni ed incrementi <i>Reducers and increasers</i> Applicazioni verticali <i>Vertical application</i> Maschio/Femmina <i>Male/Female</i>	Interno: Polipropilene bianco <i>Internal: White polypropylene</i> Esterno: Lamiera verniciata bianca <i>External: White coated steel</i> Guarnizione in EPDM <i>EPDM seals</i>	810ADAP15	da Ø80/100 a Ø80	1	21,50
	Collare a parete <i>Wall clamp</i>	Acciaio verniciato bianco <i>White coated steel</i>	10ABPRP3	Ø100	10	5,57

ACCESSORI – ACCESSORIES

IMMAGINE IMG	DESCRIZIONE DESCRIPTION	SPECIFICHE SPECIFICATIONS	CODICE PART NUMBER	DIAMETRO DIAMETER	PZ per SCA PCS per BOX	PREZZO LISTINO LIST PRICE (€)
	Riduzioni ed incrementi <i>Reducers and increasers</i> Applicazioni verticali <i>Vertical application</i> Maschio/Femmina <i>Male/Female</i>	Interno: Polipropilene bianco <i>Internal: White polypropylene</i> Esterno: Lamiera verniciata bianca <i>External: White coated steel</i> Guarnizione in EPDM <i>EPDM seals</i>	1080ADAP15	Da Ø80 a 80/100	1	21,50
	Camino <i>Vertical terminal</i> Maschio <i>Male</i>	Interno: Polipropilene bianco <i>Internal: White polypropylene</i> Esterno: Alluminio verniciato nero <i>External: Black coated aluminium</i> RESISTENTE AI RAGGI U.V. <i>U.V. RESISTANT</i>	810ST45 10125ST45	Ø80/100 Ø100/125	1 1	78,17 98,40
	Tegola camino per tetti inlinati <i>Adjustable roof flashing</i>	Alluminio - gomma - nylon <i>Aluminium - rubber - nylon</i> RESISTENTE AI RAGGI U.V. <i>U.V. RESISTANT</i>	TEJA	da Ø60 a Ø125	1	39,73
			TEJA-R	da Ø60 a Ø125 <i>Colore rosso - Red brick color</i>	1	<i>Su richiesta</i> <i>On request</i>
	Tegola camino per tetti piani <i>Flat roof flashing</i>	Nylon nero <i>Black nylon</i> RESISTENTE AI RAGGI U.V. <i>U.V. RESISTANT</i>	TEJAPLANA	da Ø60 a Ø125	1	23,12
			TEJAPLANA-R	da Ø60 a Ø125 <i>Colore rosso - Red brick color</i>	1	<i>Su richiesta</i> <i>On request</i>
	Sifone <i>Syphon</i> Per installazione verticale/ orizzontale <i>For vertical/horizontal installation</i>	Polipropilene <i>Polypropylene</i>	SIFON5 SIFONGR5	- -	1 1	19,13 23,30
	Lubrificante in tubetto monouso <i>Lubricant grease tube single use</i>	Privo di cloruro <i>Clorid free</i>	LUBRIMONO LUBRIF15 LUBRIFIBIG5	2,5 ml 30 ml 250 ml	25 10 10	1,21 3,62 8,93
	Guarnizione per linea condensazione <i>Seal for condensing systems</i>	EPDM nero <i>Black EPDM</i>	5JT6 6JT6 8JT6 10JT6 11JT6 125JT6 160JT6 200JT6 250JT6 300JT6	Ø50 Ø60 Ø80 Ø100 Ø110 Ø125 Ø160 Ø200 Ø250 Ø300	10 10 10 10 10 10 10 10 10 10	2,91 2,32 2,91 4,52 4,52 5,09 5,53 6,12 6,61 7,25





KIT SCARICO FUMI – FLUE KIT

T120-H1-W-2-O-00-LI-E-UO

IMMAGINE IMG	DESCRIZIONE DESCRIPTION	COMPATIBILITA' COMPATIBILITY	CODICE PART NUMBER	DIAMETRO DIAMETER	PZ per SCA PCS per BOX	PREZZO LISTINO LIST PRICE (€)
	Terminale orizzontale Horizontal flue kit Maschio/Femmina Male/Female Interno: Polipropilene bianco Internal: White polypropylene Esterno: Lamiera verniciata bianca External: White coated steel	BI - FE - LA - FA - UN SI - IT - NF - BO - FO AC - BAL	610KCCSIP15	Ø60/100	1	54,00
	Terminale orizzontale Horizontal flue kit Maschio/Femmina Male/Female Interno: Polipropilene bianco Internal: White polypropylene Esterno: Lamiera verniciata bianca External: White coated steel	SD - HE	610KCCSDVAP15	da Ø80/125 a Ø60/100 From Ø80/125 To Ø60/100	1	52,49
	Terminale orizzontale Horizontal flue kit Maschio/Femmina Male/Female Interno: Polipropilene bianco Internal: White polypropylene Esterno: Lamiera verniciata bianca External: White coated steel	VA	610KCCVAP15	Ø60/100	1	49,99
	Terminale orizzontale Horizontal flue kit Maschio/Femmina Male/Female Interno: Polipropilene bianco Internal: White polypropylene Esterno: Lamiera verniciata bianca External: White coated steel	JK - RB	610KCCJKP15	Ø60/100	1	52,49
	Terminale orizzontale Horizontal flue kit Maschio/Femmina Male/Female Interno: Polipropilene bianco Internal: White polypropylene Esterno: Lamiera verniciata bianca External: White coated steel	FO	610KCCFOP15	Ø60/100	1	57,99
	Terminale orizzontale Horizontal flue kit Maschio/Femmina Male/Female Interno: Polipropilene bianco Internal: White polypropylene Esterno: Lamiera verniciata bianca External: White coated steel	RA	610KCCRAP15	Ø60/100	1	57,99

Articoli compatibili solo con alcuni modelli - Chiedere info
Items compatible only with some models - Ask for info

KIT SCARICO FUMI – FLUE KIT







IMMAGINE IMG	DESCRIZIONE DESCRIPTION	COMPATIBILITA' COMPATIBILITY	CODICE PART NUMBER	DIAMETRO DIAMETER	PZ per SCA PCS per BOX	PREZZO LISTINO LIST PRICE (€)
	<p>Terminale orizzontale <i>Horizontal flue kit</i></p> <p>Maschio/Femmina <i>Male/Female</i></p> <p>Interno: Polipropilene bianco <i>Internal: White polypropylene</i></p> <p>Esterno: Lamiera verniciata bianca <i>External: White coated steel</i></p>	<p>EC - RR - RI - BE - VA AR - CH - SY - AT</p> <p>Solo fascetta <i>Only clamp</i></p>	610KCCARP15	Ø60/100	1	49,99
	<p>Terminale orizzontale <i>Horizontal flue kit</i></p> <p>Maschio/Femmina <i>Male/Female</i></p> <p>Interno: Polipropilene bianco <i>Internal: White polypropylene</i></p> <p>Esterno: Lamiera verniciata bianca <i>External: White coated steel</i></p>	<p>AG - BA - RO VI - RN</p>	610KCCVIP15	Ø60/100	1	49,99
	<p>Terminale orizzontale <i>Horizontal flue kit</i></p> <p>Maschio/Femmina <i>Male/Female</i></p> <p>Interno: Polipropilene bianco <i>Internal: White polypropylene</i></p> <p>Esterno: Lamiera verniciata bianca <i>External: White coated steel</i></p>	<p>BE - RI - SY - IN</p> <p>Manicotto e fascetta <i>Sleeve and clamp</i></p>	610KCCBEP15	Ø60/100	1	49,99
	<p>Terminale orizzontale <i>Horizontal flue kit</i></p> <p>Maschio/Femmina <i>Male/Female</i></p> <p>Interno: Polipropilene bianco <i>Internal: White polypropylene</i></p> <p>Esterno: Lamiera verniciata bianca <i>External: White coated steel</i></p>	<p>VA</p> <p>Solo fascetta <i>Only clamp</i></p>	8125KCCVAP15	Ø80/125	1	65,40

Articoli compatibili solo con alcuni modelli - Chiedere info
Items compatible only with some models - Ask for info



KIT SOSTITUZIONE TERMINALE – REPLACEMENT FLUE KIT

IMMAGINE IMG	DESCRIZIONE DESCRIPTION	CODICE PART NUMBER	DIAMETRO DIAMETER	PZ per SCA PCS per BOX	PREZZO LISTINO LIST PRICE (€)
	<p>Kit terminale di sostituzione <i>Replacement flue kit</i></p> <p>Passaggio da sistemi tradizionali a sistemi a condensazione senza opere di muratura <i>Conversion from traditional systems to condensing systems without "masonry works"</i></p>	610KCCSUST55	Ø60/100	1	37,70

PARTENZE VERTICALI – VERTICAL STARTING ADAPTERS

IMMAGINE IMG	DESCRIZIONE DESCRIPTION	COMPATIBILITA' COMPATIBILITY	CODICE PART NUMBER	DIAMETRO DIAMETER	PZ per SCA PCS per BOX	PREZZO LISTINO LIST PRICE (€)
	Partenza verticale Vertical adapter Interno: Polipropilene bianco Internal: White polypropylene Esterno: Lamiera verniciata bianca External: White coated steel	BI - FE - LA - SA - FA UN - SI - IT - NF - BO FO - ARC	610CVSIP15	Ø60/100	1	37,09
	Partenza verticale Vertical adapter Interno: Polipropilene bianco Internal: White polypropylene Esterno: Lamiera verniciata bianca External: White coated steel	JK - RB	610CVJKP15	da Ø80/125 a Ø60/100 from Ø80/125 to Ø60/100	1	62,48
	Partenza verticale Vertical adapter Interno: Polipropilene bianco Internal: White polypropylene Esterno: Lamiera verniciata bianca External: White coated steel	EC - RR - RI - BE - VA AR - CH - SY - AT - IN	610CVARP15	Ø60/100	1	20,89
	Partenza verticale Vertical adapter Interno: Polipropilene bianco Internal: White polypropylene Esterno: Lamiera verniciata bianca External: White coated steel	SD - HE	610CVSDVAP15	da Ø80/125 a Ø60/100 from Ø80/125 to Ø60/100	1	73,13
	Partenza verticale Vertical adapter Interno: Polipropilene bianco Internal: White polypropylene Esterno: Lamiera verniciata bianca External: White coated steel	AG - BA - RO VI - RN	610CVVIP15	Ø60/100	1	33,45
	Partenza verticale Vertical adapter Interno: Polipropilene bianco Internal: White polypropylene Esterno: Lamiera verniciata bianca External: White coated steel	RA	610CVRAP15	Ø60/100	1	35,04
	Partenza verticale Vertical adapter Interno: Polipropilene bianco Internal: White polypropylene Esterno: Lamiera verniciata bianca External: White coated steel	FO	610CVFOP15	Ø60/100	1	41,09





Articoli compatibili solo con alcuni modelli - Chiedere info
Items compatible only with some models - Ask for info

	<p>Partenza verticale <i>Vertical adapter</i></p> <p>Interno: Polipropilene bianco <i>Internal: White polypropylene</i></p> <p>Esterno: Polipropilene bianco <i>External: White polypropylene</i></p>	BA	610CVBA55	Ø60/100	1	24,30
	<p>Partenza verticale <i>Vertical adapter</i></p> <p>Interno: Polipropilene bianco <i>Internal: White polypropylene</i></p> <p>Esterno: Polipropilene bianco <i>External: White polypropylene</i></p>	BIA (nuovi modelli)	610CVBIA55	Ø60/100	1	22,00

NEW





Articoli compatibili solo con alcuni modelli - Chiedere info
Items compatible only with some models - Ask for info

CURVE DI PARTENZA – STARTING ELBOWS

IMMAGINE <i>IMG</i>	DESCRIZIONE <i>DESCRIPTION</i>	COMPATIBILITA' <i>COMPATIBILITY</i>	CODICE <i>PART NUMBER</i>	DIAMETRO <i>DIAMETER</i>	PZ per SCA <i>PCS per BOX</i>	PREZZO LISTINO <i>LIST PRICE (€)</i>
	<p>Curva di partenza 90° <i>90° starting elbow</i></p> <p>Interno: Polipropilene bianco <i>Internal: White polypropylene</i></p> <p>Esterno: Lamiera verniciata bianca <i>External: White coated steel</i></p>	EC - RR - RI – BE - IN VA - AR - CH - SY - AT	610CCARP15	Ø60/100	1	23,63
	<p>Curva di partenza 90° <i>90° starting elbow</i></p> <p>Interno: Polipropilene bianco <i>Internal: White polypropylene</i></p> <p>Esterno: Lamiera verniciata bianca <i>External: White coated steel</i></p>	BI - FE - LA – FA UN - SI - IT - NF - BO FO - ARC	610CCSIP15	Ø60/100	1	29,30
	<p>Curva di partenza 90° <i>90° starting elbow</i></p> <p>Interno: Polipropilene bianco <i>Internal: White polypropylene</i></p> <p>Esterno: Lamiera verniciata bianca <i>External: White coated steel</i></p>	VA	610CCVAP15	Ø60/100	1	28,55
	<p>Curva di partenza 90° <i>90° starting elbow</i></p> <p>Interno: Polipropilene bianco <i>Internal: White polypropylene</i></p> <p>Esterno: Lamiera verniciata bianca <i>External: White coated steel</i></p>	SD - HE	610CCSDVAP15	da Ø80/125 a Ø60/100 from Ø80/125 to Ø60/100	1	32,49

Articoli compatibili solo con alcuni modelli - Chiedere info
Items compatible only with some models - Ask for info





CURVE DI PARTENZA – STARTING ELBOWS

	<p>Curva di partenza 90° 90° starting elbow</p> <p>Interno: Polipropilene bianco <i>Internal: White polypropylene</i></p> <p>Esterno: Lamiera verniciata bianca <i>External: White coated steel</i></p>	JK - RB	610CCJKP15	<p>da Ø80/125 a Ø60/100</p> <p>from Ø80/125 to Ø60/100</p>	1	32,49
	<p>Curva di partenza 90° 90° starting elbow</p> <p>Interno: Polipropilene bianco <i>Internal: White polypropylene</i></p> <p>Esterno: Lamiera verniciata bianca <i>External: White coated steel</i></p>	AG - BA - RO VI - RN	610-90MHP15	Ø60/100	1	24,80
	<p>Curva di partenza 90° 90° starting elbow</p> <p>Interno: Polipropilene bianco <i>Internal: White polypropylene</i></p> <p>Esterno: Lamiera verniciata bianca <i>External: White coated steel</i></p>	FO	610CCFOP15	Ø60/100	1	34,29
	<p>Curva di partenza 90° 90° starting elbow</p> <p>Interno: Polipropilene bianco <i>Internal: White polypropylene</i></p> <p>Esterno: Lamiera verniciata bianca <i>External: White coated steel</i></p>	RA	610CCRAP15	Ø60/100	1	29,30

Articoli compatibili solo con alcuni modelli - Chiedere info
Items compatible only with some models - Ask for info





SDOPPIATORI – TWIN FLUE ADAPTERS

IMMAGINE IMG	DESCRIZIONE DESCRIPTION	COMPATIBILITA' COMPATIBILITY	CODICE PART NUMBER	DIAMETRO DIAMETER	PZ per SCA PCS per BOX	PREZZO LISTINO LIST PRICE (€)
	<p>Sdoppiatore <i>Twin flue adapter</i></p> <p>Interno: Polipropilene bianco <i>Internal: White polypropylene</i></p> <p>Esterno: Polipropilene bianco <i>External: White polypropylene</i></p>	<p>BI - FE - LA - FA - UN SI - IT - NF - BO FO - AC</p>	8ADBSIDGTH255	<p>Da Ø60/100 a Ø80/80</p> <p>From Ø60/100 to Ø80/80</p>	1	29,12
	<p>Sdoppiatore <i>Twin flue adapter</i></p> <p>Interno: Polipropilene bianco <i>Internal: White polypropylene</i></p> <p>Esterno: Polipropilene bianco <i>External: White polypropylene</i></p>	JK - RB	8ADBJK55	<p>Da Ø80/125 a Ø80/80</p> <p>From Ø80/125 to Ø80/80</p>	1	65,34
	<p>Sdoppiatore <i>Twin flue adapter</i></p> <p>Interno: Polipropilene bianco <i>Internal: White polypropylene</i></p> <p>Esterno: Polipropilene bianco <i>External: White polypropylene</i></p>	<p>EC - RR - RI - BE - VA IN - AR - CH - SY - AT</p>	8ADBBEP15	<p>Da Ø60/100 a Ø80/80</p> <p>From Ø60/100 to Ø80/80</p>	1	35,76
	<p>Sdoppiatore <i>Twin flue adapter</i></p> <p>Interno: Polipropilene bianco <i>Internal: White polypropylene</i></p> <p>Esterno: Polipropilene bianco <i>External: White polypropylene</i></p>	<p>AG - BA - RO VI - RN</p>	8ADBV15	<p>Da Ø60/100 a Ø80/80</p> <p>From Ø60/100 to Ø80/80</p>	1	34,80
	<p>Sdoppiatore <i>Twin flue adapter</i></p> <p>Interno: Polipropilene bianco <i>Internal: White polypropylene</i></p> <p>Esterno: Polipropilene bianco <i>External: White polypropylene</i></p>	SD - HE	8ADBSDVAP15	<p>Da Ø80/125 a Ø80/80</p> <p>From Ø80/125 to Ø80/80</p>	1	73,55

Articoli compatibili solo con alcuni modelli - Chiedere info
Items compatible only with some models - Ask for info

SDOPPIATORI – TWIN FLUE ADAPTERS

IMMAGINE IMG	DESCRIZIONE DESCRIPTION	COMPATIBILITA' COMPATIBILITY	CODICE PART NUMBER	DIAMETRO DIAMETER	PZ per SCA PCS per BOX	PREZZO LISTINO LIST PRICE (€)
	<p>Sdoppiatore <i>Twin flue adapter</i></p> <p>Interno: Polipropilene bianco <i>Internal: White polypropylene</i></p> <p>Esterno: Polipropilene bianco <i>External: White polypropylene</i></p>	RA	8ADBRAP15	Da $\varnothing 60/100$ a $\varnothing 80/80$ From $\varnothing 60/100$ to $\varnothing 80/80$	1	50,73
	<p>Sdoppiatore <i>Twin flue adapter</i></p> <p>Interno : Polipropilene bianco <i>Internal : White Polypropylene</i></p> <p>Esterno : Polipropilene bianco <i>External : White Polypropylene</i></p>	BA (nuovi modelli)	8ADBBA55	Da $\varnothing 60/100$ a $\varnothing 80/80$ From $\varnothing 60/100$ to $\varnothing 80/80$	1	32,00

NEW

Articoli compatibili solo con alcuni modelli - Chiedere info
Items compatible only with some models - Ask for info

SDOPPIATORE MULTICOMPATIBILE MULTI-COMPATIBLE TWIN FLUE ADAPTER

NEW

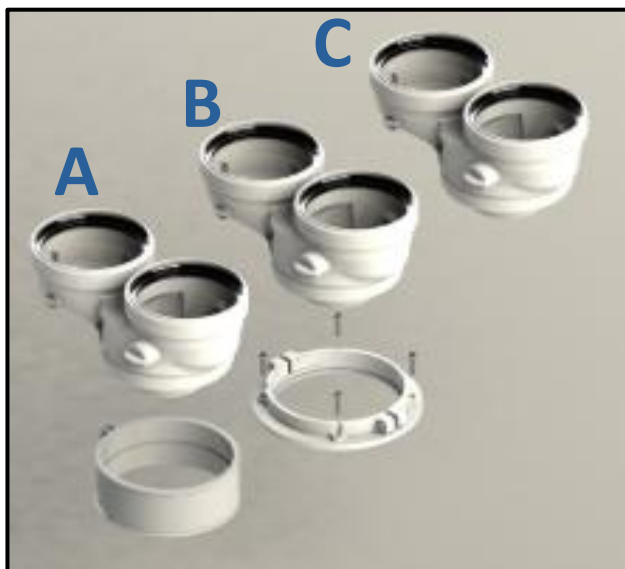

8ADBMULTI55

32,00 €

Sdoppiatore MULTICOMPATIBILE - Twin flue adapter MULTICOMPATIBILE

Materiale: Polipropilene bianco – Material: White Polypropylene

Da 60/100 a 80-80 - From $\varnothing 60/100$ to 80-80

A

AR – BE – CH
EC – RR – RI
IN – VA – CH
SY - AT







B

SI – IT – BL
AIR – SD – FE
FO – LA – NF
UN – JO – BO
BI - ARC

C

AG – BA – RO
VI – RN – WO
DAI – RE -
BE EX

PARTENZE SEPARATE – TWIN STARTING ADAPTERS

IMMAGINE IMG	DESCRIZIONE DESCRIPTION	COMPATIBILITA' COMPATIBILITY	CODICE PART NUMBER	DIAMETRO DIAMETER	PZ per SCA PCS per BOX	PREZZO LISTINO LIST PRICE (€)
	Partenze separate Twin starting adapters Polipropilene bianco White polypropylene	SI - UN - ARC FE - FA - BI - IT	8MADBSI5	Ø80/80	1	25,12
	Partenze separate Twin starting adapters Polipropilene bianco White polypropylene	AR – CH (SOLO EVACUAZIONE)	8MADBAR5	Ø80/80	1	19,40
	Partenze separate Twin starting adapters Polipropilene bianco White polypropylene	RA	8MADBRA5	Ø80/80	1	25,12
	Partenze separate Twin starting adapters Polipropilene bianco White polypropylene	FO	8MADBF05	Ø80/80	1	29,09
	Partenze separate Twin starting adapters Polipropilene bianco White polypropylene	BA - AR – CH - IN BE - SY - VI - RI	8MADBBE5	Ø80/80	1	37,64
	Partenze separate Twin starting adapters Polipropilene bianco White polypropylene	IM	8MADBIMM5	Ø80/80	1	21,00

Articoli compatibili solo con alcuni modelli - Chiedere info
Items compatible only with some models - Ask for info

KIT SCARICO FUMI MULTICOMPATIBILI MULTI COMPATIBLE FLUE KIT

IMMAGINE IMG	DESCRIZIONE DESCRIPTION	COMPATIBILITA' COMPATIBILITY	CODICE PART NUMBER	DIAMETRO DIAMETER	PZ per SCA PCS per BOX	PREZZO LISTINO LIST PRICE (€)
	Terminale orizzontale Horizontal flue kit Maschio/Femmina Male/Female Interno: Polipropilene bianco Internal: White polypropylene Esterno: Lamiera verniciata bianca External: White coated steel	JK - RB SD - HE	610KCCMULTIP15B	Da Ø80/125 a Ø60/100	1	81,48
	Terminale orizzontale Horizontal flue kit Maschio/Femmina Male/Female Interno: Polipropilene bianco Internal: White polypropylene Esterno: Lamiera verniciata bianca External: White coated steel	SI - IT - BAL - SD - FE LA - NF - UN - O ARC - BI - AR - BE - CH ECO - RE - RI - SY - VA AT - IN - AG - BA - RO VI - RN	610KCCMULTIP15C	Ø60/100	1	38,00
	Terminale orizzontale Horizontal flue kit Maschio/Femmina Male/Female Int - Ext: Polipropilene bianco ANTI UV Int - Ext: White polypropylene No UV	SI - IT - BAL - SD - FE FO - LA - NF - UN - O ARC - BI - AR - BE - CH ECO - RE - RI - SY - VA AT - IN - AG - BA - RO VI - RN	610KCCMULTI55	Ø60/100	1	34,00
	Terminale orizzontale Horizontal flue kit Maschio/Femmina Male/Female Int - Ext: Polipropilene bianco ANTI UV Int - Ext: White polypropylene No UV	JK - RB SD - HE	610KCCMULTI55B	Ø60/100	1	53,20



Articoli compatibili solo con alcuni modelli - Chiedere info

Items compatible only with some models - Ask for info







PARTENZE VERTICALI MULTICOMPATIBILI MULTI-COMPATIBLE VERTICAL STARTING ADAPTERS

IMMAGINE IMG	DESCRIZIONE DESCRIPTION	COMPATIBILITA' COMPATIBILITY	CODICE PART NUMBER	DIAMETRO DIAMETER	PZ per SCA PCS per BOX	PREZZO LISTINO LIST PRICE (€)
	Partenza verticale Vertical adapter Maschio/Femmina Male/Female Interno: Polipropilene bianco Internal: White polypropylene Esterno: Lamiera verniciata bianca External: White coated steel	BI - LA - SI - UN FO - VA - AR - IT VI - FE - RA - RI CH - BE - SY - BA RO - EC - RN - IN	610CVMULTIP15A	Ø60/100	1	40,14
	Partenza verticale Vertical adapter Maschio/Femmina Male/Female Interno: Polipropilene bianco Internal: White polypropylene Esterno: Lamiera verniciata bianca External: White coated steel	JK - RB SD - HE	610CVMULTIP15B	Da Ø80/125 a Ø60/100	1	61,83

Articoli compatibili solo con alcuni modelli - Chiedere info

Items compatible only with some models - Ask for info

KIT SCARICO FUMI MULTICOMPATIBILI PP/PP - MULTI COMPATIBLE FLUE KIT - PP/PP

IMMAGINE IMG	DESCRIZIONE DESCRIPTION	COMPATIBILITA' COMPATIBILITY	CODICE PART NUMBER	DIAMETRO DIAMETER	PZ per SCA PCS per BOX	PREZZO LISTINO LIST PRICE (€)
	Terminale orizzontale <i>Horizontal flue kit</i> Maschio/Femmina <i>Male/Female</i> Interno: Polipropilene bianco <i>Internal: White polypropylene</i> Esterno: Polipropilene bianco <i>External: White polypropylene</i>	BE - RI - SY	610KCCBE55EX	Ø60/100	1	42,00
	Terminale orizzontale <i>Horizontal flue kit</i> Maschio/Femmina <i>Male/Female</i> Int - Ext: Polipropilene bianco ANTI UV <i>Int - Ext: White polypropylene No UV</i>	VA - AR - BA VI - RI - RO CH - BE - SY - AT RN - EC	610KCCBE55	Ø60/100	1	38,00
	Terminale orizzontale <i>Horizontal flue kit</i> Maschio/Femmina <i>Male/Female</i> Int - Ext: Polipropilene bianco ANTI UV <i>Int - Ext: White polypropylene No UV</i>	BI - LA - SI - UN - IT BAL - FE - ARC	610KCCSI55	Ø60/100	1	38,00
	Terminale orizzontale <i>Horizontal flue kit</i> Maschio/Femmina <i>Male/Female</i> Int - Ext: Polipropilene bianco ANTI UV <i>Int - Ext: White polypropylene No UV</i>	JK - RB	610KCCJK55	Ø60/100	1	40,00
	Terminale orizzontale <i>Horizontal flue kit</i> Maschio/Femmina <i>Male/Female</i> Int - Ext: Polipropilene bianco ANTI UV <i>Int - Ext: White polypropylene No UV</i>	SD - HE	610KCCSDVA55	Ø60/100	1	40,00
	Terminale orizzontale <i>Horizontal flue kit</i> Maschio/Femmina <i>Male/Female</i> Int - Ext: Polipropilene bianco ANTI UV <i>Int - Ext: White polypropylene No UV</i>	BA (nuovi modelli)	610KCCBA55	Ø60/100	1	34,00

NEW

NEW

NEW

Articoli compatibili solo con alcuni modelli - Chiedere info
Items compatible only with some models - Ask for info



GROPPALLI
FLUE SYSTEMS
DISTRIBUZIONE

LINEA

TRADIZIONALE

FLUE PIPES FOR TRADITIONAL BOILERS

SISTEMA MONOPARETE
SISTEMA COASSIALE
KIT COMPATIBILI

*SINGLE WALL SYSTEM
DOUBLE WALL SYSTEM
COMPATIBLE KITS*

T200-P1-D-Vm-L13100-070

8ST18

TEJA

8-1000MHP1

8-45MHP1

8DFV4







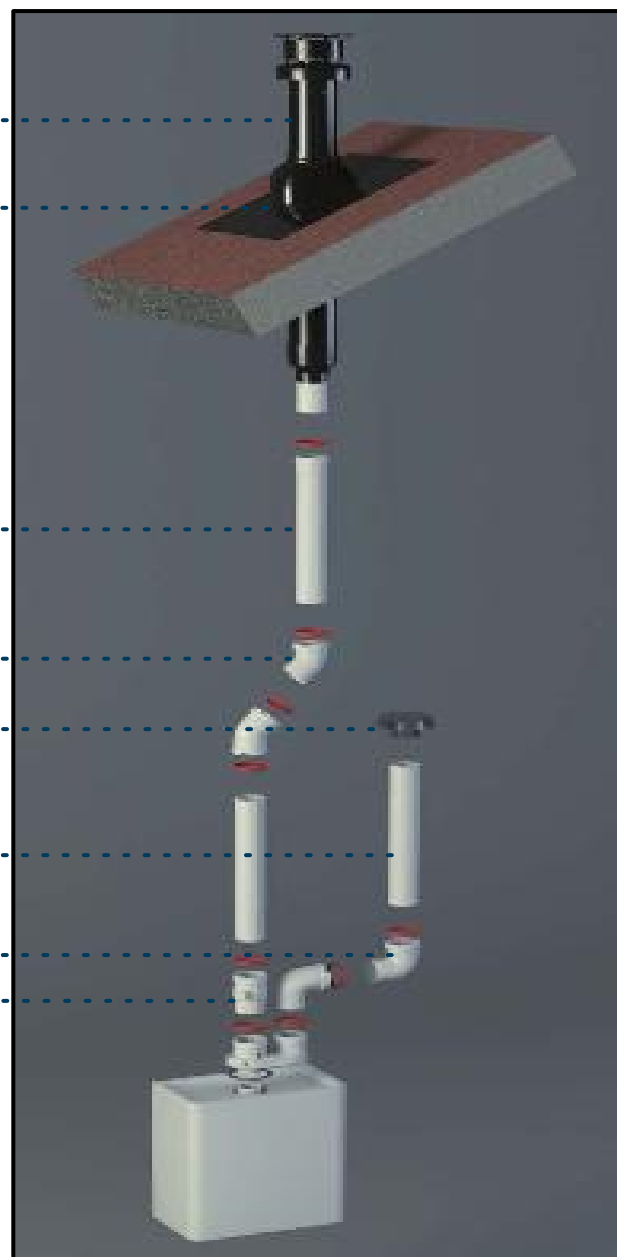



8-1000MHP1

8-90MHP1

8RCMHP1



SISTEMA MONOPARETE - ESEMPIO DI INSTALLAZIONE
SINGLE WALL SYSTEM - INSTALLATION EXAMPLE



IMMAGINE IMG	DESCRIZIONE DESCRIPTION	SPECIFICHE SPECIFICATIONS	CODICE PART NUMBER	DIAMETRO DIAMETER	PZ per SCA PCS per BOX	PREZZO LISTINO LIST PRICE (€)
	Prolunghe Extensions Maschio/Femmina Male/Female	Alluminio verniciato bianco White coated aluminium Guarnizione in silicone Silicone seals	6-250MHP1	Ø60 - L=250	20	8,65
			6-500MHP1	Ø60 - L=500	10	12,24
			6-1000MHP1	Ø60 - L=1000	10	17,49
			6-2000MHP1	Ø60 - L=2000	10	33,35
			8-250MHP1	Ø80 - L=250	20	7,31
			8-500MHP1	Ø80 - L=500	10	10,88
			8-1000MHP1	Ø80 - L=1000	10	18,19
			8-2000MHP1	Ø80 - L=2000	6	40,25
	Curve 90° 90° elbows Maschio/Femmina Male/Female	Alluminio verniciato bianco White coated aluminium Guarnizione in silicone Silicone seals *AL pressofuso – Die cast AL	6-90MHP1	Ø60	10	20,57
			8-90MHP1-B	Ø80	10	11,90
			8-90MHP1 *	Ø80	10	16,70
	Curve 45° 45° elbows Maschio/Femmina Male/Female	Alluminio verniciato bianco White coated aluminium Guarnizione in silicone Silicone seals *AL pressofuso – Die cast AL	6-45MHP1	Ø60	10	17,47
			8-45MHP1-B	Ø80	10	10,84
			8-45MHP1 *	Ø80	10	14,45
	Curve 90° 90° elbows Femmina/Femmina Femmina/Female	Alluminio verniciato bianco White coated aluminium Guarnizione in silicone Silicone seal	6-90HHP1	Ø60	10	28,05
			8-90HHP1	Ø80	10	20,57
	Curve 45° 45° elbows Femmina/Femmina Femmina/Female	Alluminio verniciato bianco White coated aluminium Guarnizione in silicone Silicone seal	8-45HHP1	Ø80	10	20,36
	Manicotto unione Double union adapter Femmina/Femmina Femmina/Female	Alluminio verniciato bianco White coated aluminium Guarnizione in silicone Silicone seal	6MTTP1	Ø60	10	12,24
			8MTTP1	Ø80	10	10,97
	Tee con tappo raccoglicondensa Tee with condensing drain cap Maschio/maschio/femmina Male/male/female	Alluminio verniciato bianco White coated aluminium Guarnizione in silicone Silicone seal	6TEP1	Ø60	10	47,85
			8TEP1	Ø80	10	37,49
	Tee Tee Maschio/maschio/femmina Male/male/female	Alluminio verniciato bianco White coated aluminium Guarnizione in silicone Silicone seal	8TEP1-ST	Ø80	10	28,50
	Tappo raccoglicondensa Condensing drain cap Femmina Female	Alluminio verniciato bianco White coated aluminium Guarnizione in silicone Silicone seal	8TAPEP1	Ø80	10	15,31
	Tronchetto raccoglicondensa Condensing trap Maschio/Femmina Male/Female	Alluminio verniciato bianco White coated aluminium Guarnizione in silicone Silicone seal	8RCMHP1	Ø80	1	32,64
	Riduzioni Reductions Maschio/Femmina Male/Female	Alluminio verniciato bianco White coated aluminium Guarnizione in silicone Silicone seal	68AMPMP1	M 60 / F 80	1	13,12
			86REDMHP1	M 80 / F 60	1	9,80
			810AMPMP1	M 80 / F 100	1	13,12

TERMINALI - TERMINALS





IMMAGINE IMG	DESCRIZIONE DESCRIPTION	SPECIFICHE SPECIFICATIONS	CODICE PART NUMBER	DIAMETRO DIAMETER	MINIMO ORD MIN ORD.QTY	PREZZO LISTINO LIST PRICE (€)
	Griglia scarico fumi verticale <i>Vertical grid for flue gas exit</i> Femmina <i>Female</i>	Inox 304 <i>Stainless steel</i>	6DFV4	Ø60	10	17,62
			8DFV4	Ø80	10	16,85
			10DFV4	Ø100	10	21,91
			125DFV4	Ø125	1	55,04
	Griglia scarico fumi orizzontale <i>Horizontal grid for flue gas exit</i> Femmina <i>Female</i>	Inox 304 <i>Stainless steel</i>	5DFH4	Ø50	10	12,03
			6DFH4	Ø60	10	7,58
			8DFH4	Ø80	10	7,77
			10DFH4	Ø100	10	13,06
	Griglia aspirazione orizzontale con parapioggia <i>Horizontal grid with rain cover air inlet</i> Femmina <i>Female</i>	Inox 304 <i>Stainless steel</i>	6DFHALL4	Ø60	10	14,63
			8DFHALL4	Ø80	10	15,70
	Griglia aspirazione orizzontale <i>Horizontal grid - Air inlet</i> Femmina <i>Female</i>	Inox 304 <i>Stainless steel</i>	6DFHCAL4	Ø60	10	7,22
			8DFHCAL4	Ø80	10	7,71
	Griglia aspirazione orizzontale <i>Horizontal grid - Air inlet</i> Femmina <i>Female</i>	Inox 304 <i>Stainless steel</i>	6DFHTA4	Ø60	10	9,05
			8DFHTA4	Ø80	10	11,23
			10DFHTA4	Ø100	10	14,09
	Griglia aspirazione orizzontale <i>Horizontal grid - Air inlet</i> Femmina <i>Female</i>	Inox 304 <i>Stainless steel</i>	6DFHCA4	Ø60	10	5,64
			8DFHCA4	Ø80	10	6,51
	Griglia aspirazione orizzontale <i>Horizontal grid - Air inlet</i> Femmina <i>Female</i>	Polipropilene grigio <i>Grey Polypropylene</i> RESISTENTE AI RAGGI U.V. <i>U.V. RESISTANT</i>	8DFH7	Ø80	10	3,48
	Griglia scarico fumi orizzontale <i>Horizontal grid for flue gas exit</i> Femmina <i>Female</i>	Nylon nero <i>Black nylon</i> RESISTENTE AI RAGGI U.V. <i>U.V. RESISTANT</i>	8DFH47	Ø80	10	4,14
	Griglia aspirazione/scarico <i>Aspiration/evacuation grid</i> Femmina <i>Female</i>	Nylon bianco <i>White nylon</i> RESISTENTE AI RAGGI U.V. <i>U.V. RESISTANT</i>	6DFH7	Ø60	10	3,89
	Camino <i>Vertical terminal</i> Maschio <i>Male</i>	Alluminio nero <i>Black aluminium</i> RESISTENTE AI RAGGI U.V. <i>U.V. RESISTANT</i>	8ST18 + 68AMPMP1*	Ø60	1	100,78 + 13,12
			8ST18	Ø80	1	100,78

*Per diametri più piccoli abbinare riduzioni al codice 85T18



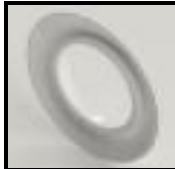

TERMINALI - TERMINALS

IMMAGINE IMG	DESCRIZIONE DESCRIPTION	SPECIFICHE SPECIFICATIONS	CODICE PART NUMBER	DIAMETRO DIAMETER	PZ per SCA PCS per BOX	PREZZO LISTINO LIST PRICE (€)
	Terminale camino Chimney flue cap	Alluminio nero Black aluminium RESISTENTE AI RAGGI U.V. U.V. RESISTANT	8DFV18	Ø80	1	28,43
	Tegola camino per tetti inclinati Adjustable roof flashing	Alluminio - gomma - nylon Aluminium - rubber - nylon RESISTENTE AI RAGGI U.V. U.V. RESISTANT	TEJA	da Ø60 a Ø125	1	39,73
			TEJA-R	da Ø60 a Ø125	1	Su richiesta On request
			Colore rosso - Red brick color			
	Tegola camino per tetti piani Flat roof flashing	Nylon nero Black nylon RESISTENTE AI RAGGI U.V. U.V. RESISTANT	TEJAPLANA	da Ø60 a Ø125	1	23,12
			TEJAPLANA-R	da Ø60 a Ø125	1	Su richiesta On request
			Colore rosso - Red brick color			

ACCESSORI - ACCESSORIES

IMMAGINE IMG	DESCRIZIONE DESCRIPTION	SPECIFICHE SPECIFICATIONS	CODICE PART NUMBER	DIAMETRO DIAMETER	PZ per SCA PCS per BOX	PREZZO LISTINO LIST PRICE (€)
	Rosone per installazione esterna Wall plate for external installation	EPDM bianco White EPDM	5PL6	Ø50	10	3,86
			6PL6	Ø60	10	2,16
			8PL6	Ø80	10	2,16
			10PL6	Ø100	10	2,53
			125PL6	Ø125	10	7,25
	Rosone per installazione interna Wall plate for internal installation	Ø80 - Chemiton Ø100 - Ø125 - Polyethylene Bianco White	8PL6-INT	Ø80	10	2,16
			10PL6-INT	Ø100	10	3,12
			125PL6-INT	Ø125	10	7,25
	Rosone per installazione esterna Wall plate for external installation	EPDM grigio Grey EPDM	6PL6-G	Ø60	10	2,16
			10PL6-G	Ø100	10	2,53
			125PL6-G	Ø125	10	7,25
	Rosone per installazione esterna Wall plate for external installation	EPDM nero Black EPDM RESISTENTE AI RAGGI U.V. U.V. RESISTANT	6PL6-NERO	Ø60	10	2,16
			8PL6-NERO	Ø80	10	2,30
			10PL6-NERO	Ø100	10	4,33
			125PL6-NERO	Ø125	10	8,25
	Collare a parete Wall clamp	Acciaio verniciato bianco White coated steel	6ABSOPORTMURO	Ø60	1	9,43
			8ABSOPORTMURO	Ø80	1	9,87
			10ABSOPORTMURO	Ø100	1	14,51
	Fascetta con Manicotto Sleeve connetion	Acciaio verniciato bianco e gomma EPDM White coated steel and grey EPDM	10ABTTP1	Ø 100	1	5,75

ACCESSORI - ACCESSORIES

IMMAGINE IMG	DESCRIZIONE DESCRIPTION	SPECIFICHE SPECIFICATIONS	CODICE PART NUMBER	DIAMETRO DIAMETER	PZ per SCA PCS per BOX	PREZZO LISTINO LIST PRICE (€)
	Collare di serraggio <i>Locking collar</i>	Acciaio zincato <i>Galvanized steel</i>	5ABSOPORTFLEX	Ø50	1	10,73
			6ABSOPORTFLEX	Ø60	1	9,76
			8ABSOPORTFLEX	Ø80	1	9,86
			10ABSOPORTFLEX	Ø100	1	10,62
			125ABSOPORTFLEX	Ø125	1	13,54
			160ABSOPORTFLEX	Ø160	1	21,90
	Collare a parete <i>Wall clamp</i>	Acciaio verniciato bianco <i>White coated steel</i>	6ABPRP3	Ø60	10	4,19
			8ABPRP3	Ø80	10	4,60
			10ABPRP3	Ø100	10	5,57
			11ABPRP3	Ø110	10	6,74
			125ABPRP3	Ø125	10	6,86
	Lubrificante in tubetto o monouso <i>Lubricant grease tube or single use</i>	Privo di cloruro <i>Clorid free</i>	LUBRIMONO	2,5 ml	25	1,21
			LUBRIFI5	30 ml	10	3,62
			LUBRIFIBG5	250 ml	10	6,93
	Guarnizione per sistema tradizionale <i>Seal for traditional system</i>	Silicone <i>Silicone</i>	6JTSIL	Ø60	10	0,62
			8JTSIL	Ø80	10	0,94
			10JTSIL	Ø100	10	2,02

SISTEMA COASSIALE – ESEMPIO DI INSTALLAZIONE
DOUBLE WALL SYSTEM – INSTALLATION EXAMPLE

T160-P1-D-Vm-L13100-O00



IMMAGINE IMG	DESCRIZIONE DESCRIPTION	SPECIFICHE SPECIFICATIONS	CODICE PART NUMBER	DIAMETRO DIAMETER	PZ per SCA PCS per BOX	PREZZO LISTINO LIST PRICE (€)
	Prolunghe <i>Extensions</i>	Interno: alluminio <i>Internal: aluminium</i>	610-250MHP1	Ø60/100 - L=250	1	19,75
			610-500MHP1	Ø60/100 - L=500	1	18,72
			610-1000MHP1	Ø60/100 - L=1000	1	29,74
			610-2000MHP1	Ø60/100 - L=2000	1	65,11
			8125-250MHP1	Ø80/125 - L=250	1	19,19
			8125-500MHP1	Ø80/125 - L=500	1	32,35
			8125-1000MHP1	Ø80/125 - L=1000	1	44,94
			8125-2000MHP1	Ø80/125 - L=2000	1	73,13
	Maschio/Femmina <i>Male/Female</i>	Guarnizioni in silicone <i>Silicone seals</i>				
	Curve 90° <i>90° elbows</i>	Interno: alluminio <i>Internal: aluminium</i>	610-90MHP1	Ø60/100	1	23,40
			8125-90MHP1	Ø80/125	1	40,73
	Maschio/Femmina <i>Male/Female</i>	Guarnizioni in silicone <i>Silicone seals</i>				
	Curve 45° <i>45° elbows</i>	Interno: alluminio <i>Internal: aluminium</i>	610-45MHP1	Ø60/100	1	28,75
			8125-45MHP1	Ø80/125	1	39,37
	Maschio/Femmina <i>Male/Female</i>	Guarnizioni in silicone <i>Silicone seals</i>				
	Curve 90° <i>90° elbows</i>	Interno: alluminio <i>Internal: aluminium</i>	610-90HHP1	Ø60/100	1	32,49
			8125-90HHP1	Ø80/125	1	57,96
	Femmina/Femmina <i>Female/Female</i>	Guarnizioni in silicone <i>Silicone seals</i>				
	Manicotto unione <i>Double union adapter</i>	Interno: alluminio <i>Internal: aluminium</i>	610MTTP1	Ø60/100	1	12,33
	Femmina/Femmina <i>Female/Female</i>	Guarnizioni in silicone <i>Silicone seals</i>				
	Tronchetto raccogli condensa <i>Condensing trap</i>	Interno: alluminio <i>Internal: aluminium</i>	610RCMHP1	Ø60/100	1	38,83
	Maschio/Femmina <i>Male/Female</i>	Guarnizioni in silicone <i>Silicone seals</i>				
	Tronchetto per ispezione <i>Analysis extension</i>	Interno: alluminio <i>Internal: aluminium</i>	610TMMHP1	Ø60/100	1	24,67
	Maschio/Femmina <i>Male/Female</i>	Guarnizioni in silicone <i>Silicone seals</i>				
	Curva 90° con ispezione <i>90° Elbow with inspection</i>	Interno: alluminio <i>Internal: aluminium</i>	610-90TMMHP1	Ø60/100	1	28,43
	Maschio/Femmina <i>Male/Female</i>	Guarnizioni in silicone <i>Silicone seals</i>				





IMMAGINE IMG	DESCRIZIONE DESCRIPTION	SPECIFICHE SPECIFICATIONS	CODICE PART NUMBER	DIAMETRO DIAMETER	PZ per SCA PCS per BOX	PREZZO LISTINO LIST PRICE (€)
	Riduzioni Reductions Maschio/Femmina Male/Female	Interno: Alluminio Internal: aluminium Esterno: Lamiera verniciata bianca External: White coated steel Guarnizione in silicone Silicone seals	6810125AMPMP1	M Ø60/100 - F Ø80/125	1	29,05
	Partenza branchiale Starter kit adapter Installazione esterna External installation	Acciaio verniciato bianco White painted iron	610CVB22P1	Da Ø60 / 100 a Ø80 From Ø60 / 100 to Ø80	1	40,00

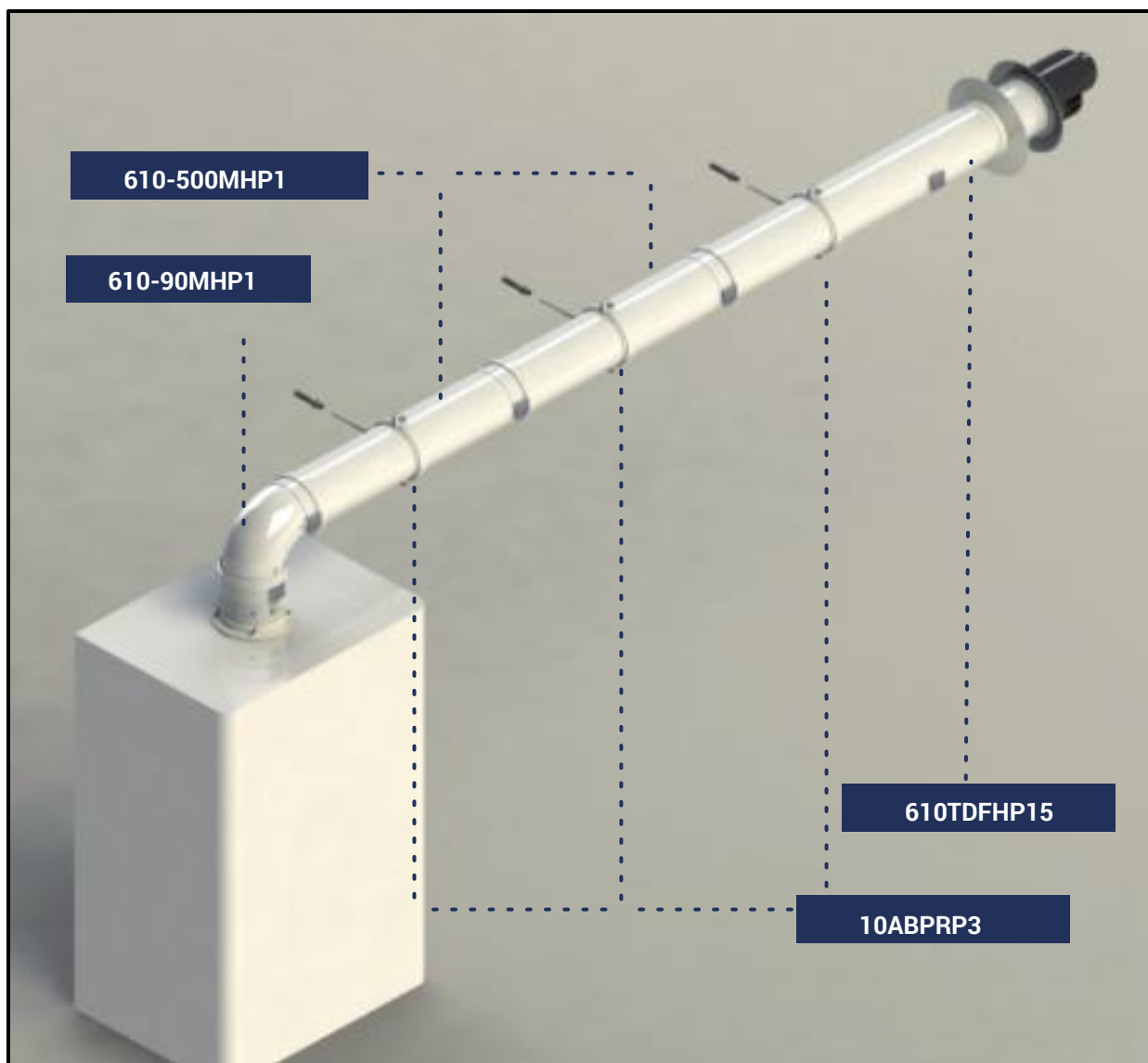





TERMINALI -TERMINALS

IMMAGINE IMG	DESCRIZIONE DESCRIPTION	SPECIFICHE SPECIFICATIONS	CODICE PART NUMBER	DIAMETRO DIAMETER	PZ per SCA PCS per BOX	PREZZO LISTINO LIST PRICE (€)
	Terminale orizzontale Horizontal terminal Maschio/Femmina Male/Female	Interno: Alluminio Internal: Aluminium Esterno: Lamiera verniciata bianca External: White coated steel Guarnizione in silicone Silicone seals	610TDFHP17	Ø60/100	1	33,80
	Griglia aspirazione/scarico Air/flue grid Femmina Female	Nylon grigio Grey nylon RESISTENTE AI RAGGI U.V. U.V. RESISTANT	610DFH7	Ø60/100	1	6,35
	Griglia aspirazione/scarico Aspiration/evacuation grid Femmina Female	Nylon grigio Grey nylon RESISTENTE AI RAGGI U.V. U.V. RESISTANT	6DFH7	Ø60	10	3,89
	Griglia aspirazione/scarico Aspiration/evacuation grid Femmina Female	Nylon Bianco White nylon RESISTENTE AI RAGGI U.V. U.V. RESISTANT	610DFH7W	Ø60/100	10	6,35
	Camino Vertical terminal Maschio Male	Interno: Alluminio Internal: aluminium Esterno: Alluminio nero External: Black coated aluminium RESISTENTE AI RAGGI U.V. U.V. RESISTANT	610ST18 8125ST18	Ø60 / 100 Ø80 / 125	1 1	107,72 108,95
	Testata camino verticale Chimney flue cap Femmina Female	Nylon nero Black nylon RESISTENTE AI RAGGI U.V. U.V. RESISTANT	610DFV18	Ø60/100	1	24,99
	Griglia aspirazione/scarico Air/flue grid Installazione orizzontale Horizontal installation	Nylon nero Black nylon RESISTENTE AI RAGGI U.V. U.V. RESISTANT	8125DFH7	Ø80/125	1	7,64







TERMINALI - TERMINALS

IMMAGINE IMG	DESCRIZIONE DESCRIPTION	SPECIFICHE SPECIFICATIONS	CODICE PART NUMBER	DIAMETRO DIAMETER	PZ per SCA PCS per BOX	PREZZO LISTINO LIST PRICE (€)
	Testata camino verticale Chimney flue cap Femmina Female	Nylon nero Black nylon RESISTENTE AI RAGGI U.V. U.V. RESISTANT	8125DFV18	Ø80/125	1	56,86
	Tegola camino per tetti inclinati Adjustable roof flashing	Alluminio - gomma - nylon Aluminium - rubber - nylon RESISTENTE AI RAGGI U.V. U.V. RESISTANT	TEJA	da Ø60 a Ø125	1	39,73
			TEJA-R	da Ø60 a Ø125	1	Su richiesta On request
			Colore rosso - Red brick color			
	Tegola camino per tetti piani Flat roof flashing	Nylon nero Black nylon RESISTENTE AI RAGGI U.V. U.V. RESISTANT	TEJAPLANA	da Ø60 a Ø125	1	23,12
			TEJAPLANA-R	da Ø60 a Ø125	1	Su richiesta On request
			Colore rosso - Red brick color			

ACCESSORI - ACCESSORIES

IMMAGINE IMG	DESCRIZIONE DESCRIPTION	SPECIFICHE SPECIFICATIONS	CODICE PART NUMBER	DIAMETRO DIAMETER	PZ per SCA PCS per BOX	PREZZO LISTINO LIST PRICE (€)
	Rosone per installazione esterna Wall plate for external installation	EPDM bianco White EPDM	10PL6	Ø100	10	2,53
			125PL6	Ø125	10	7,25
	Rosone per installazione interna Wall plate for internal installation	Ø80 - Chemiton Ø100 - Ø125 - Polyethylene Bianco White	10PL6-INT	Ø100	10	3,12
			125PL6-INT	Ø125	10	7,25
	Rosone per installazione esterna Wall plate for external installation	EPDM grigio Grey EPDM	10PL6-G	Ø100	10	2,53
			125PL6-G	Ø125	10	7,25
	Collare a parete Wall clamp	Acciaio verniciato Coated steel	10ABSOPORTMURO	Ø100	1	14,51
			125ABSOPORTMURO	Ø125	1	15,38
	Collare per supporto orizzontale Horizontal support bracket	Acciaio zincato Galvanized steel	SOPORTEHOR250	Da Ø50 a Ø 160	1	27,41
	Collare a parete Wall clamp	Acciaio verniciato bianco White coated steel	10ABPRP3	Ø100	10	5,57
			125ABPRP3	Ø125	10	6,86

KIT SCARICO FUMI – FLUE KIT

IMMAGINE IMG	DESCRIZIONE DESCRIPTION	COMPATIBILITA' COMPATIBILITY	CODICE PART NUMBER	DIAMETRO DIAMETER	PZ per SCA PCS per BOX	PREZZO LISTINO LIST PRICE (€)
	Terminale orizzontale <i>Horizontal flue kit</i> Maschio/Femmina <i>Male/Female</i> Interno: Alluminio <i>Internal: Aluminium</i> Esterno: Lamiera verniciata bianca <i>External: White coated steel</i>	RI - BE - SY - IN	610KCCBEP1	Ø60/100	1	70,62
	Terminale orizzontale <i>Horizontal flue kit</i> Maschio/Femmina <i>Male/Female</i> Interno: Alluminio <i>Internal: Aluminium</i> Esterno: Lamiera verniciata bianca <i>External: White coated steel</i>	IM	610KCCIMMP1	Ø60/100	1	67,49
	Terminale orizzontale <i>Horizontal flue kit</i> Maschio/Femmina <i>Male/Female</i> Interno: Alluminio <i>Internal: Aluminium</i> Esterno: Lamiera verniciata bianca <i>External: White coated steel</i>	JK - RB	610KCCJKP1	Ø60/100	1	65,49
	Terminale orizzontale <i>Horizontal flue kit</i> Maschio/Femmina <i>Male/Female</i> Interno: Alluminio <i>Internal: Aluminium</i> Esterno: Lamiera verniciata bianca <i>External: White coated steel</i>	SI	610KCCSIP1	Ø60/100	1	60,04
	Terminale orizzontale <i>Horizontal flue kit</i> Maschio/Femmina <i>Male/Female</i> Interno: Alluminio <i>Internal: Aluminium</i> Esterno: Lamiera verniciata bianca <i>External: White coated steel</i>	AR - CH - EC - VI VA - AG - BA - RO	610KCCVAP1	Ø60/100	1	44,99
	Terminale orizzontale <i>Horizontal flue kit</i> Maschio/Femmina <i>Male/Female</i> Interno: Alluminio <i>Internal: Aluminium</i> Esterno: Lamiera verniciata bianca <i>External: White coated steel</i>	BI - FE - FO - LA - ARC NF - IT - RA - UN FA - BO	610KCCUP1	Ø60/100	1	49,48
		FO	610KCCFONDP1	Ø60/100	1	62,52
	Terminale orizzontale <i>Horizontal flue kit</i> Maschio/Femmina <i>Male/Female</i> Interno: Alluminio <i>Internal: Aluminium</i> Esterno: Lamiera verniciata bianca <i>External: White coated steel</i>	SD - HE	610KCCSDP1	Ø60/100	1	58,15





Articoli compatibili solo con alcuni modelli - Chiedere info
Items compatible only with some models - Ask for info

KIT SCARICO FUMI – FLUE KIT

IMMAGINE IMG	DESCRIZIONE DESCRIPTION	COMPATIBILITA' COMPATIBILITY	CODICE PART NUMBER	DIAMETRO DIAMETER	PZ per SCA PCS per BOX	PREZZO LISTINO LIST PRICE (€)
	Terminale orizzontale <i>Horizontal flue kit</i> Maschio/Femmina <i>Male/Female</i> Interno: Alluminio <i>Internal: Aluminium</i> Esterno: Lamiera verniciata bianca <i>External: White coated steel</i>	SI	610KCCSICLP1	Ø60/100	1	47,20





Articolo compatibile solo con alcuni modelli - Chiedere info
 Item compatible only with some models - Ask for info

PARTENZE VERTICALI – VERTICAL STARTING ADAPTERS

IMMAGINE IMG	DESCRIZIONE DESCRIPTION	COMPATIBILITA' COMPATIBILITY	CODICE PART NUMBER	DIAMETRO DIAMETER	PZ per SCA PCS per BOX	PREZZO LISTINO LIST PRICE (€)
	Partenza verticale <i>Vertical adapter</i> Interno: Alluminio <i>Internal: Aluminium</i> Esterno: Lamiera verniciata bianca <i>External: White coated steel</i>	BI - FE - FO - LA - ARC NF - IT - RA - SA - UN FA - BO	610CVUP1	Ø60/100	1	31,84
	Partenza verticale <i>Vertical adapter</i> Interno: Alluminio <i>Internal: Aluminium</i> Esterno: Lamiera verniciata bianca <i>External: White coated steel</i>	JK - RB	610CVJKP1	Ø60/100	1	40,99
	Partenza verticale <i>Vertical adapter</i> Interno: Alluminio <i>Internal: Aluminium</i> Esterno: Lamiera verniciata bianca <i>External: White coated steel</i>	FE	610CVFERP1	Ø60/100	1	20,89
	Partenza verticale <i>Vertical adapter</i> Interno: Alluminio <i>Internal: Aluminium</i> Esterno: Lamiera verniciata bianca <i>External: White coated steel</i>	SI	610CVSIP1	Ø60/100	1	40,99
	Partenza verticale <i>Vertical adapter</i> Interno: Alluminio <i>Internal: Aluminium</i> Esterno: Lamiera verniciata bianca <i>External: White coated steel</i>	IM	610CVIMMP1	Ø60/100	1	41,80



Articoli compatibili solo con alcuni modelli - Chiedere info
 Items compatible only with some models - Ask for info

PARTENZE VERTICALI – VERTICAL STARTING ADAPTERS

IMMAGINE IMG	DESCRIZIONE DESCRIPTION	COMPATIBILITA' COMPATIBILITY	CODICE PART NUMBER	DIAMETRO DIAMETER	PZ per SCA PCS per BOX	PREZZO LISTINO LIST PRICE (€)
	Partenza verticale <i>Vertical adapter</i> Interno: Alluminio <i>Internal: Aluminium</i> Esterno: Lamiera verniciata bianca <i>External: White coated steel</i>	VA	610CVVAP1	Ø60/100	1	34,87
	Partenza verticale <i>Vertical adapter</i> Interno: Alluminio <i>Internal: Aluminium</i> Esterno: Lamiera verniciata bianca <i>External: White coated steel</i>	SD - HE	610CVSDP1	Ø60/100	1	32,88
	Partenza verticale <i>Vertical adapter</i> Interno: Alluminio <i>Internal: Aluminium</i> Esterno: Lamiera verniciata bianca <i>External: White coated steel</i>	RI - BE – SY - IN	610CVBEP1	Ø60/100	1	37,49
	Partenza verticale <i>Vertical adapter</i> Interno: Alluminio <i>Internal: Aluminium</i> Esterno: Lamiera verniciata bianca <i>External: White coated steel</i>	AR - CH	610CVARP1	Ø60/100	1	19,68





Articoli compatibili solo con alcuni modelli - Chiedere info
Items compatible only with some models - Ask for info

SDOPPIATORI – TWIN FLUE ADAPTERS

IMMAGINE IMG	DESCRIZIONE DESCRIPTION	COMPATIBILITA' COMPATIBILITY	CODICE PART NUMBER	DIAMETRO DIAMETER	PZ per SCA PCS per BOX	PREZZO LISTINO LIST PRICE (€)
	Sdoppiatore <i>Twin flue adapter</i> Interno: Ryton <i>Internal: Ryton</i> Esterno: Polipropilene bianco <i>External: White Polypropylene</i>	BI - FE - FO - LA - ARC NF - IT - RA - UN FA - BO	8ADBUP1	Da Ø60/100 a Ø80/80 From Ø60/100 to Ø80/80	1	41,80
	Sdoppiatore <i>Twin flue adapter</i> Interno: Ryton <i>Internal: Ryton</i> Esterno: Polipropilene bianco <i>External: White Polypropylene</i>	JK - RB	8ADBJKP1-610 8ADBJKP1-610M <i>(corpo metallico)</i> 8ADBJKP1-811 <i>(corpo metallico)</i>	Da Ø60/100 a Ø80/80 Da Ø80/100 a Ø80/80	1 1 1	59,99 59,99 59,99
	Sdoppiatore <i>Twin flue adapter</i> Interno: Ryton <i>Internal: Ryton</i> Esterno: Polipropilene bianco <i>External: White Polypropylene</i>	SI	8ADBUSIP1	Da Ø60/100 a Ø80/80 From Ø60/100 to Ø80/80	1	45,99

Articoli compatibili solo con alcuni modelli - Chiedere info
Items compatible only with some models - Ask for info

SDOPPIATORI – TWIN FLUE ADAPTERS

IMMAGINE IMG	DESCRIZIONE DESCRIPTION	COMPATIBILITA' COMPATIBILITY	CODICE PART NUMBER	DIAMETRO DIAMETER	PZ per SCA PCS per BOX	PREZZO LISTINO LIST PRICE (€)
	Sdoppiatore <i>Twin flue adapter</i> Interno: Ryton <i>Internal: Ryton</i> Esterno: Polipropilene bianco <i>External: White Polypropylene</i>	RI - BE - SY - IN	8ADBBEP1	Da Ø60/100 a Ø80/80 From Ø60/100 to Ø80/80	1	58,48
	Sdoppiatore <i>Twin flue adapter</i> Interno: Ryton <i>Internal: Ryton</i> Esterno: Polipropilene bianco <i>External: White Polypropylene</i>	AR - CH - VA	8ADBARP1	Da Ø60/100 a Ø80/80 From Ø60/100 to Ø80/80	1	47,49
	Sdoppiatore <i>Twin flue adapter</i> Interno: Ryton <i>Internal: Ryton</i> Esterno: Polipropilene bianco <i>External: White Polypropylene</i>	AG - BA - RO - VI	8ADBFAP1	Da Ø60/100 a Ø80/80 From Ø60/100 to Ø80/80	1	56,47
	Sdoppiatore <i>Twin flue adapter</i> Interno: Ryton <i>Internal: Ryton</i> Esterno: Polipropilene bianco <i>External: White Polypropylene</i>	SD - HE	8ADBSDP1	Da Ø60/100 a Ø80/80 From Ø60/100 to Ø80/80	1	75,23





Articoli compatibili solo con alcuni modelli - Chiedere info
 Items compatible only with some models - Ask for info

PARTENZE SEPARATE – TWIN STARTING ADAPTERS

IMMAGINE IMG	DESCRIZIONE DESCRIPTION	COMPATIBILITA' COMPATIBILITY	CODICE PART NUMBER	DIAMETRO DIAMETER	PZ per SCA PCS per BOX	PREZZO LISTINO LIST PRICE (€)
	Partenze separate <i>Twin starting adapters</i> Alluminio verniciato bianco <i>White painted aluminium</i>	BI - FE - FO - LA - ARC NF - IT - RA - UN FA - BO	8MADBUP1	Ø80/80	1	39,19
	Partenze separate <i>Twin starting adapters</i> Alluminio verniciato bianco <i>White painted aluminium</i>	JK - RB	8MADBJKP1	Ø80/80	1	52,24

Articoli compatibili solo con alcuni modelli - Chiedere info
 Items compatible only with some models - Ask for info

PARTENZE SEPARATE – TWIN STARTING ADAPTERS

IMMAGINE IMG	DESCRIZIONE DESCRIPTION	COMPATIBILITA' COMPATIBILITY	CODICE PART NUMBER	DIAMETRO DIAMETER	PZ per SCA PCS per BOX	PREZZO LISTINO LIST PRICE (€)
	Partenze separate Twin starting adapters Alluminio verniciato bianco White painted aluminium	FE	8MADBFERP1	Ø80/80	1	42,29
	Partenze separate Twin starting adapters Alluminio verniciato bianco White painted aluminium	BA - RO - AG - VI	8MADBBAP1	Ø80/80	1	41,80
	Partenze separate Twin starting adapters Alluminio verniciato bianco White painted aluminium	AR - CH	8MADBARP1	Da Ø60/100 a Ø80 From Ø60/100 to Ø80	1	25,10
	Partenze separate Twin starting adapters Alluminio verniciato bianco White painted aluminium	IM	8MADBIMMP1	Ø80/80	1	40,00

Articoli compatibili solo con alcuni modelli - Chiedere info
Items compatible only with some models - Ask for info

KIT SCARICO FUMI MULTICOMPATIBILE

MULTI-COMPATIBLE FLUE KIT

IMMAGINE IMG	DESCRIZIONE DESCRIPTION	COMPATIBILITA' COMPATIBILITY	CODICE PART NUMBER	DIAMETRO DIAMETER	PZ per SCA PCS per BOX	PREZZO LISTINO LIST PRICE (€)
	Terminale orizzontale <i>Horizontal flue kit</i> Maschio/Femmina <i>Male/Female</i> Interno: Alluminio <i>Internal: Aluminium</i> Esterno: Lamiera verniciata bianca <i>External: White coated steel</i>	TUTTI I MARCHI TRANNE IMM ALL BOILER BRANDS EXCEPT IM	610KCCMULTIP1	Ø60/100	1	64,48

PARTENZA VERTICALE MULTICOMPATIBILE

MULTI-COMPATIBLE VERTICAL STARTING ADAPTER

IMMAGINE IMG	DESCRIZIONE DESCRIPTION	COMPATIBILITA' COMPATIBILITY	CODICE PART NUMBER	DIAMETRO DIAMETER	PZ per SCA PCS per BOX	PREZZO LISTINO LIST PRICE (€)
	Partenza verticale <i>Vertical adapter</i> Interno: Alluminio <i>Internal: Aluminium</i> Esterno: Lamiera verniciata bianca <i>External: White coated steel</i>	TUTTI I MARCHI TRANNE IMM ALL BOILER BRANDS EXCEPT IM	610CVMULTIP1	Ø60/100	1	44,60

CURVA DI PARTENZA MULTICOMPATIBILE

MULTI-COMPATIBLE STARTING ELBOW

IMMAGINE IMG	DESCRIZIONE DESCRIPTION	COMPATIBILITA' COMPATIBILITY	CODICE PART NUMBER	DIAMETRO DIAMETER	PZ per SCA PCS per BOX	PREZZO LISTINO LIST PRICE (€)
	Curva di partenza 90° <i>90° starting elbow</i> Interno: Alluminio <i>Internal: Aluminium</i> Esterno: Lamiera verniciata bianca <i>External: White coated steel</i>	TUTTI I MARCHI TRANNE IMM ALL BOILER BRANDS EXCEPT IM	610CCMULTIP1	Ø60/100	1	40,79

SDOPPIATORE MULTICOMPATIBILE

MULTI-COMPATIBLE TWIN FLUE ADAPTER

IMMAGINE IMG	DESCRIZIONE DESCRIPTION	COMPATIBILITA' COMPATIBILITY	CODICE PART NUMBER	DIAMETRO DIAMETER	PZ per SCA PCS per BOX	PREZZO LISTINO LIST PRICE (€)
	Sdoppiatore <i>Twin flue adapter</i> Interno: Alluminio <i>Internal: Aluminium</i> Esterno: Lamiera verniciata bianca <i>External: White coated steel</i>	TUTTI I MARCHI TRANNE IMM ALL BOILER BRANDS EXCEPT IM	8ADBMULTIP1	Ø60/100	1	48,80

Articoli compatibili solo con alcuni modelli - Chiedere info
Items compatible only with some models - Ask for info

ACCESSORI



GROPPALLI
FLUE SYSTEMS
DISTRIBUZIONE

CONDIZIONAMENTO

ACCESSORIES FOR AIR CONDITIONING SYSTEMS

STAFFE
SUPPORTI A PAVIMENTO
CANALINA
TUBO SCARICO CONDENZA
NASTRI ANTICONDENZA
RACCORDERIA

SUPPORT BRACKETS
FLOOR SUPPORTS
DUCTS
CONDENSATE DRAIN PIPE
CANDENSATE TAPES
FITTINGS



LINEA STAFFE
SUPPORT BRACKETS

DESCRIZIONE DESCRIPTION	SPECIFICHE SPECIFICATIONS	CODICE ARTICOLO ARTICLE CODE	MISURA SIZE (mm)	Pz/Conf Pcs/ Box	PREZZO PRICE (€)	
Mensola in acciaio ricoperta da plastica anticorrosione e anti-UV Bulloneria inclusa	Con traversa Pallet completo: 32 pz With crossbar Full pallet: 32 pcs	Portata Load capacity 100 kg MENSOLTEK	L440 x H405	1	50,22	
	Senza traversa Pallet completo: 96 pz No crossbar Full pallet: 96 pcs	Portata Load capacity 100 kg MENSOLTEK-ST	L440 x H360	1	40,76	
Mensola in acciaio verniciato con traversa Montaggio rapido	Bulloneria inclusa Screws included	Portata Load capacity 80 kg MENCT-80	L450 x H380	1	24,15	
		Bancale completo Full pallet 105 pcs				
Mensola in acciaio premontata con traversa CHIEDERE DISPONIBILITÀ	Acciaio elettrozincato Bulloneria inclusa Electro-galvanized iron Screws included	Portata Load capacity 150 kg MENCT-150	L420 x H500	1	37,00	
		Bancale completo Full pallet 100 pcs				
Mensola in acciaio premontata con traversa Preassembled iron bracket with crosspiece	Acciaio elettrozincato Bulloneria inclusa Electro-galvanized iron Screws included	Portata Load capacity 150 kg MENCT-150L60	L600 x H500	1	41,45	
Mensola in acciaio premontata con traversa Preassembled iron bracket with crosspiece	Acciaio elettrozincato Bulloneria inclusa Electro galvanized iron Screws included	Portata Load capacity 160 kg MENCT-160	L550 x H400	1	41,45	
		Bancale completo Full pallet 120 pcs				

**ACCESSORI
CONDIZIONAMENTO**

**ACCESSORIES FOR
CONDITIONING
SYSTEMS**

**ACCESSORI
CONDIZIONAMENTO**

**ACCESSORIES FOR
CONDITIONING
SYSTEMS**

SUPPORTI A PAVIMENTO
FLOOR SUPPORTS

DESCRIZIONE DESCRIPTION	SPECIFICHE SPECIFICATIONS	CODICE ARTICOLO ARTICLE CODE	MISURA SIZE (mm)	Pz/Conf Pcs/Box	PREZZO PRICE (€)	
Supporti a pavimento trapezoidali per condizionatori Trapezoidal floor supports for air conditioning system	In PVC bianco Confezionati in coppia White PVC Pair packed	SUPAV80-350	80 x 80 L=350	24 Minimo Ord. Min. q.ty	4,93 Prezzo cad Single price	
		SUPAV80-450	80 x 80 L=450	24 Minimo Ord. Min. q.ty	5,71 Prezzo cad Single price	
		SUPAV80-1000	80 x 80 L=1000	4 Minimo Ord. Min. q.ty	13,02 Prezzo cad Single price	
		SUPAV80-CAP	TAPPI 80 x 80	24 Minimo Ord. Min. q.ty	1,26 Prezzo cad Single price	
Supporti a pavimento trapezoidali per condizionatori Trapezoidal floor supports for air conditioning system	In PVC bianco Confezionati in coppia White PVC Pair packed	SUPAV100-350	100 x 100 L=350	24 Minimo Ord. Min. q.ty	6,62 Prezzo cad Single price	
		SUPAV100-450	100 x 100 L=450	24 Minimo Ord. Min. q.ty	7,67 Prezzo cad Single price	
		SUPAV100-1000	100 x 100 L=1000	4 Minimo Ord. Min. q.ty	14,91 Prezzo cad Single price	
		SUPAV100-CAP	TAPPI 100 x 100	24 Minimo Ord. Min. q.ty	1,54 Prezzo cad Single price	
Kit 4 supporti a pavimento conici per condizionatori Conical floor supports for air conditioning system	In PVC rigido Rigid PVC	SUPPORTI-COND01-PERLA	Ø55 - H95	1	16,63 Prezzo kit 4 pz 4 pcs kit price	
Kit 4 supporti a pavimento conici per condizionatori Conical floor supports for air conditioning system	In nylon Nero Peso max. per Singolo piede: 150Kg Black nylon	SUPPORTI-COND01	Ø80 - H90	1	16,63 Prezzo kit 4 pz 4 pcs kit price	
	In nylon Bianco Max. capacity for single piece: 150Kg White nylon	SUPPORTI-COND01-B	Ø80 - H90	1	16,63 Prezzo kit 4 pz 4 pcs kit price	
Kit 4 supporti a pavimento conici regolabili Conical floor adjustable supports	In PP nero ANTI UV Black PP No UV	SUPPORTI-COND02-N	Ø80 - H90	1	21,90 Prezzo kit 4 pz 4 pcs kit price	
	In PP bianco ANTI UV White PP No UV	SUPPORTI-COND02-B	Ø80 - H90	1	20,96 Prezzo kit 4 pz 4 pcs kit price	
Kit 2 supporti a pavimento antivibranti No vibrations floor supports	In gomma SBR nera Black SBR rubber	BASEPAV-400-AA	L=400	1	53,20 Prezzo kit 2 pz 2 pcs kit price	
		BASEPAV-600-AA	L=600	1	67,84 Prezzo kit 2 pz 2 pcs kit price	

ACCESSORI PER CONDIZIONAMENTO ACCESSORIES FOR AIR CONDITIONING SYSTEMS



GROPPALLI
FLUE SYSTEMS
DISTRIBUZIONE

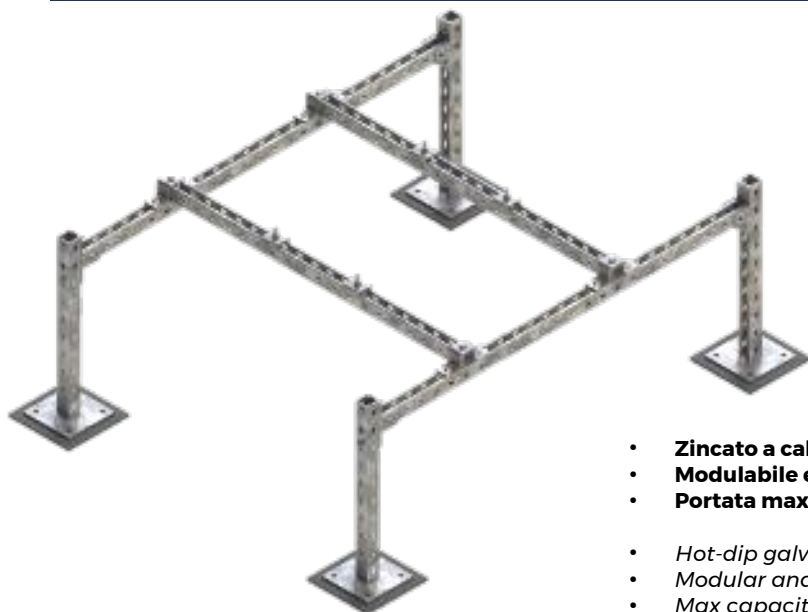

- **Zincato a caldo dopo lavorazione**
- **Modulabile e regolabile**
- **Portata max: 1000 kg**
- *Hot-dip galvanized*
- *Modular and adjustable*
- *Max capacity: 1000 kg*

DESCRIZIONE DESCRIPTION	CODICE ARTICOLO ARTICLE CODE	MISURA SIZE (mm)	Pz/Conf Pcs/ Box	PREZZO PRICE (€)
Supporto profilato modulare per pompe di calore <i>Modular support frames for heat pumps or air conditioning</i>	SUPROFIL100120	1000 x 1200 H=500	1	370,00

CANALINA ELEGANCE (Senza viti di unione) ELEGANCE DUCTS (without joint screws)

DESCRIZIONE DESCRIPTION	SPECIFICHE SPECIFICATIONS	CODICE ARTICOLO ARTICLE CODE	MISURA SIZE (mm)	Pz/Conf Pcs/ Box	PREZZO PRICE (€)
Prolunga 2 m <i>2 m extension</i>	In polipropilene bianco seta <i>Con viti e tasselli per fissaggio a muro With screws and wall plugs included</i> <i>Silky-white polypropylene</i>	PROL2000-CANP-GRIGIA	60 x 57 L=2000	6	
		PROL2000-CAN-GRIGIA	77 x 67 L=2000	6	
		PROL2000-CANG-GRIGIA	107 x 77 L=2000	6	
Curva 90° <i>90° elbow</i>	In polipropilene bianco seta <i>Silky-white polypropylene</i>	CURVANGOLO-CANP-GRIGIA	60 x 57 - 90°	10	
		CURVANGOLO-CAN-GRIGIA	77 x 67 - 90°	10	
		CURVANGOLO-CANG-GRIGIA	107 x 77 - 90°	10	
Curva piatta 90° <i>Flat 90° elbow</i>	In polipropilene bianco seta <i>Con viti e tasselli per fissaggio a muro With screws and wall plugs included</i> <i>Silky-white polypropylene</i>	CURVAPIANA-CANP-GRIGIA	60 x 57 - 90°	10	
		CURVAPIANA-CAN-GRIGIA	77 x 67 - 90°	10	
		CURVAPIANA-CANG-GRIGIA	107 x 77 - 90°	10	

NEW

Nuovo sistema di unione SENZA VITI

New joint system WITHOUT SCREWS







**ACCESSORI
CONDIZIONAMENTO**

**ACCESSORIES FOR
CONDITIONING
SYSTEMS**

**Nuovo sistema di
unione SENZA VITI**

**New joint system
WITHOUT SCREWS**

CANALINA ELEGANCE (Senza viti di unione)
ELEGANCE DUCTS (without joint screws)

DESCRIZIONE DESCRIPTION	SPECIFICHE SPECIFICATIONS	CODICE ARTICOLO ARTICLE CODE	MISURA SIZE (mm)	Pz/Conf Pcs/ Box	PREZZO PRICE (€)	
Giunto <i>Joint</i>	In polipropilene bianco seta <i>Con viti e tasselli per fissaggio a muro With screws and wall plugs included</i> <i>Silky-white polypropylene</i>	GIUNTO-CANP-GRIGIA	60 x 57	10		
		GIUNTO-CAN-GRIGIA	77 x 67	10		
		GIUNTO-CANG-GRIGIA	107 x 77	10		
Raccordo a TEE <i>TEE connection</i>	In polipropilene bianco seta <i>Con viti e tasselli per fissaggio a muro With screws and wall plugs included</i> <i>Silky-white polypropylene</i>	RACCORDO-CAN-GRIGIA	77 x 67	10		
		RACCORDO-CANG-GRIGIA	107 x 77	10		
Terminale <i>Terminal</i>	In polipropilene bianco seta <i>Silky-white polypropylene</i>	TERMINALE-CANP-GRIGIA	60 x 57	10		
		TERMINALE-CAN-GRIGIA	77 x 67	10		
		TERMINALE-CANG-GRIGIA	107 x 77	10		
Terminale a muro <i>Wall terminal</i>	In polipropilene bianco seta <i>Con viti e tasselli per fissaggio a muro With screws and wall plugs included</i> <i>Silky-white polypropylene</i>	TERMURO-CANP-GRIGIA	60 x 57	10		
		TERMURO-CAN-GRIGIA	77 x 67	10		
		TERMURO-CANG-GRIGIA	107 x 77	10		
Riduzione <i>Reduction</i>	In polipropilene bianco seta <i>Silky-white polypropylene</i>	RID-CAN-GRIGIA	77 x 67	10		
		RID-CANG-GRIGIA	107 x 77	10		
Rosone <i>Wallplate</i>	In polipropilene bianco seta <i>Silky-white polypropylene</i>	ROSONE-CANP	60 x 57	10		
		ROSONE-CAN	77 x 67	10		
		ROSONE-CANG	107 x 77	10		
Passa Fascetta <i>Cable tie holder</i>	In polipropilene trasparente con fascetta in nylon, vite e tassello per fissaggio a muro <i>In transparent polypropylene with nylon cable tie, screw and wall plugs.</i>	PASSAFASCIA-CAN		1		

ACCESSORI PER CONDIZIONAMENTO ACCESSORIES FOR AIR CONDITIONING SYSTEMS



GROPPALLI
FLUE SYSTEMS
DISTRIBUZIONE

DESCRIZIONE DESCRIPTION	SPECIFICHE SPECIFICATIONS	CODICE ARTICOLO ARTICLE CODE	MISURA SIZE (mm)	Pz/Conf Pcs/Box	PREZZO PRICE (€)
----------------------------	------------------------------	---------------------------------	------------------------	--------------------	------------------------

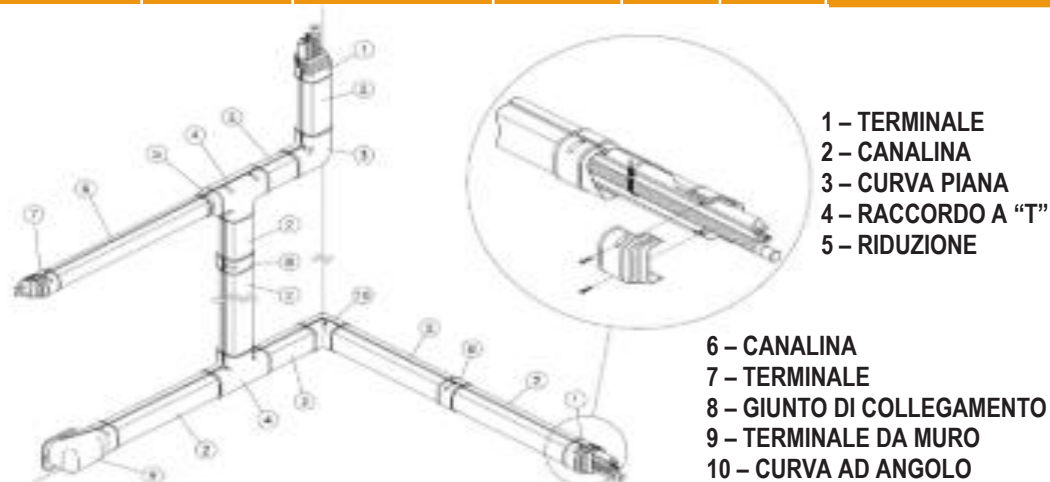

- 1 - TERMINALE
- 2 - CANALINA
- 3 - CURVA PIANA
- 4 - RACCORDO A "T"
- 5 - RIDUZIONE
- 6 - CANALINA
- 7 - TERMINALE
- 8 - GIUNTO DI COLLEGAMENTO
- 9 - TERMINALE DA MURO
- 10 - CURVA AD ANGOLO

ATTENZIONE: Gli articoli della linea ELEGANCE non sono compatibili con gli articoli della linea BASIC
WARNING: Items of the ELEGANCE line are not compatible with items of the BASIC line

CANALINA BASIC BASIC DUCTS

DESCRIZIONE DESCRIPTION	SPECIFICHE SPECIFICATIONS	CODICE ARTICOLO ARTICLE CODE	MISURA SIZE (mm)	Pz/Conf Pcs/Box	PREZZO PRICE (€)
----------------------------	------------------------------	---------------------------------	------------------------	--------------------	------------------------







Prolunga 2 m 2 m extension	In PVC bianco puro Pure-white PVC	PROFILM2000-P	60 x 45 L=2000	12	8,89	
		PROFILM2000-M	80 x 60 L=2000	8	12,39	
		PROFILM2000-G	110 x 75 L=2000	4	19,22	
Staffe fissaggio cavi Cable-fixing brackets	In PVC colori vari Various colors PVC	PF.CANBLOCK-P	60 x 45	30	0,35	
		PF.CANBLOCK-M	80 x 60	30	0,39	
		PF.CANBLOCK-G	110 x 75	20	0,46	
Giunto Joint	In PVC bianco puro Pure-white PVC	PF.GIUNTO-P	60 x 45	30	1,37	
		PF.GIUNTO-M	80 x 60	30	1,61	
		PF.GIUNTO-G	110 x 75	20	2,03	
Angolo Internal corner	In PVC bianco puro Pure-white PVC	PF.ANGINT-P	60 x 45	8	2,45	
		PF.ANGINT-M	80 x 60	6	2,80	
		PF.ANGINT-G	110 x 75	4	3,50	

ACCESSORI CONDIZIONAMENTO

ACCESSORIES FOR CONDITIONING SYSTEMS

**ACCESSORI
CONDIZIONAMENTO**

**ACCESSORIES FOR
CONDITIONING
SYSTEMS**

DESCRIZIONE DESCRIPTION	SPECIFICHE SPECIFICATIONS	CODICE ARTICOLO ARTICLE CODE	MISURA SIZE (mm)	Pz/Conf Pcs/Box	PREZZO PRICE (€)	
Angolo esterno External corner	In PVC bianco puro Pure-white PVC	PF.ANGEST-P	60 x 45	12	2,45	
		PF.ANGEST-M	80 x 60	9	2,80	
		PF.ANGEST-G	110 x 75	6	3,50	
Curva piatta Plane elbow	In PVC bianco puro Pure-white PVC	PF.CURVAPIANA-P	60 x 45	10	2,80	
		PF.CURVAPIANA-M	80 x 60	8	3,78	
		PF.CURVAPIANA-G	110 x 75	6	5,04	
Curva a muro Corner wall elbow	In PVC bianco puro Pure-white PVC	PF.CURMURO-P	60 x 45	9	3,19	
		PF.CURMURO-M	80 x 60	6	3,47	
		PF.CURMURO-G	110 x 75	4	4,87	
Passaggio a muro Wall passage	In PVC bianco puro Pure-white PVC	PF.WALPAS-P	60 x 45	10	2,38	
		PF.WALPAS-M	80 x 60	16	2,66	
		PF.WALPAS-G	110 x 75	8	4,03	
Raccordo a TEE Tee connection	In PVC bianco puro Pure-white PVC	PF.RACT-M	80 x 60	4	5,78	
		PF.RACT-G	110 x 75	4	7,25	
Riduzione Reduction	In PVC bianco puro Pure-white PVC	PF.RID-M	Da 80 x 60 a 60 x 45	12	2,07	
		PF.RID-G	Da 110 x 75 a 80 x 60	8	2,35	
Tappo terminale End cap	In PVC bianco puro Pure-white PVC	PF.TAPPOTERM-P	60 x 45	12	2,28	
		PF.TAPPOTERM-M	80 x 60	9	2,66	

ATTENZIONE: Gli articoli della linea BASIC non sono compatibili con gli articoli della linea ELEGANCE
WARNING: Items of the BASIC line are not compatible with items of the ELEGANCE line

TUBO SCARICO CONDENSA RIGIDO
RIGID CONDENSATE DRAIN PIPE

DESCRIZIONE DESCRIPTION	SPECIFICHE SPECIFICATIONS	CODICE ARTICOLO ARTICLE CODE	MISURA SIZE (mm)	Pz/Conf Pcs/Box	PREZZO PRICE (€)	
Tubo scarico condensa rigido <i>Rigid condensate drain pipe</i>	In PVC bianco <i>White PVC</i>	RIGPIPE-20	Ø20 - L =2000	35	3,56	
Clips per tubo scarico condensa Ø20 <i>Clips for condensate drain pipe - Ø20</i>	In PVC bianco <i>White PVC</i>	RIGPIPE-20.CLIP	Ø20	100	0,39	
Manicotto per tubo rigido Ø20 <i>Rigid pipe connector - Ø20</i>	In PVC bianco <i>White PVC</i>	RP-CONNECT	Ø20	20	2,63	
Angolo per tubo rigido 135° - Ø20 <i>Rigid pipe 135° corner - Ø20</i>	In PVC bianco <i>White PVC</i>	RP-CORNER	Ø20	20	2,94	
Curva 90° per tubo rigido - Ø20 <i>Rigid pipe 90° corner - Ø20</i>	In PVC bianco <i>White PVC</i>	RP-90BEND	Ø20	20	2,94	
Raccordo a tee per tubo rigido Ø20 <i>Rigid tee Derivation - Ø20</i>	In PVC bianco <i>White PVC</i>	RP-RACTEE	Ø20	20	3,75	
Riduzione per tubo rigido <i>Reduction for rigid pipe</i>	In PVC bianco <i>White PVC</i>	RIGRED-2520	Da Ø25 a Ø20	20	2,70	
		RIGRED-3225	Da Ø32 a Ø25	20	3,71	

ACCESSORI
CONDIZIONAMENTO
ACCESSORIES FOR
CONDITIONING
SYSTEMS







Accessori
con O-RING

**Accessori
con GUARNIZIONI**

DESCRIZIONE DESCRIPTION	SPECIFICHE SPECIFICATIONS	CODICE ARTICOLO ARTICLE CODE	MISURA SIZE (mm)	Pz/Conf Pcs/Box	PREZZO PRICE (€)	
Manicotto per tubo rigido Ø20 <i>Rigid pipe connector Ø20</i>	In PVC bianco <i>White PVC</i>	RP-CONNECT-GU	Ø20	30	1,86	
Angolo per tubo rigido 135° Ø20 <i>Rigid pipe 135° corner Ø20</i>	In PVC bianco <i>White PVC</i>	RP-CORNER-GU	Ø20	30	1,86	
Curva 90° per tubo rigido Ø20 <i>Rigid pipe 90° corner Ø20</i>	In PVC bianco <i>White PVC</i>	RP-90BEND-GU	Ø20	30	1,86	
Raccordo a tee per tubo rigido Ø20 <i>Rigid tee derivation for rigid pipe Ø20</i>	In PVC bianco <i>White PVC</i>	RP-RACTEE-GU	Ø20	30	1,89	
Riduzione per tubo rigido <i>Reduction for rigid pipe</i>	In PVC bianco <i>White PVC</i>	RIGRED2520-GU	Da Ø25 a Ø20	30	1,89	
		RIGRED3225-GU	Da Ø32 a Ø25	30	2,14	



TUBO SCARICO CONDENSA SPIRALATO
SPIRAL CONDENSATE DRAIN PIPE

DESCRIZIONE DESCRIPTION	SPECIFICHE SPECIFICATIONS	CODICE ARTICOLO ARTICLE CODE	MISURA SIZE (mm)	Pz/Conf Pcs/ Box	PREZZO PRICE (€)	
Tubo scarico condensa spiralato <i>Spiral condensate drain pipe</i>	In PVC bianco Sono necessari accessori <i>White PVC Accessories needed</i>	SPIRPIPE-16	Ø16 Rotolo da 30 m	1	31,05	
		SPIRPIPE-18	Ø18 Rotolo da 30 m	1	35,35	
		SPIRPIPE-20	Ø20 Rotolo da 30 m	1	37,31	
		SPIRPIPE-25	Ø25 Rotolo da 30 m	1	44,98	
Raccordo da tubo rigido Ø20 a tubo spiralato <i>Connector from rigid pipe Ø20 to spiral pipe</i>	Gomma <i>Rubber</i>	UNIRAC-16 (giallo)	Ø16	10	3,10	
		UNIRAC-18 (rosso)	Ø18	10	3,18	
		UNIRAC-20 (blu)	Ø20	10	3,27	
		UNIRAC-22 (azzurro)	Ø22	10	3,30	
		UNIRAC-25 (verde)	Ø25	10	3,34	
		UNIRAC-32 (grigio)	Ø32	10	3,42	
Giunto a Y asimmetrico per tubo spiralato Ø16 e Ø18 <i>Asymmetrical Y joint for Ø16 and Ø18 spiral pipe</i>	PVC <i>PVC</i>	RACSPIR-Y	Ø16 - Ø18	20	1,33	
Giunto a Y simmetrico per tubo spiralato Ø16 - Ø18 - Ø20 <i>Symmetrical Y joint for Ø16 - Ø18 - Ø20 spiral pipe</i>	PVC <i>PVC</i>	RACSPIR-YUNI	Ø16 - Ø18 - Ø20	20	1,82	
Giunto lineare per tubo spiralato Ø16 - Ø18 - Ø20 <i>Linear joint for Ø16 - Ø18 - Ø20 spiral pipe</i>	PVC <i>PVC</i>	RACSPIR-GIU	Ø16 - Ø18 - Ø20	20	0,91	
Sifone per tubo spiralato Ø16 - Ø18 - Ø20 <i>Syphon for spiral pipe Ø16 - Ø18 - Ø20</i>	PVC <i>PVC</i>	RACSPIR-SYPH	Ø16 - Ø18 - Ø20	10	2,91	
Tee per tubo spiralato Ø16 - Ø18 - Ø20 <i>Tee derivation for spiral pipe Ø16 - Ø18 - Ø20</i>	PVC <i>PVC</i>	RACSPIR-TEE	Ø16 - Ø18 - Ø20	20	2,10	

ACCESSORI
CONDIZIONAMENTO
ACCESSORIES FOR
CONDITIONING
SYSTEMS

**ACCESSORI
CONDIZIONAMENTO**

**ACCESSORIES FOR
CONDITIONING
SYSTEMS**

CANALINA PER TUBO SCARICO CONDENSA
DUCT FOR DRAIN PIPES

DESCRIZIONE DESCRIPTION	SPECIFICHE SPECIFICATIONS	CODICE ARTICOLO ARTICLE CODE	MISURA SIZE (mm)	Pz/Conf Pcs/ Box	PREZZO PRICE (€)	
Canalina per tubo scarico condensa	In PVC bianco puro	PROFILM2000-SPIR2525	25 x 25 L = 2000	32	3,13	
Duct for spiraled pipe	Pure-white PVC	PROFILM2000-SPIR3035	30 x 35 L = 2000	32	5,41	

TUBO SCARICO CONDENSA CORRUGATO
CORRUGATED CONDENSATE DRAIN PIPE

DESCRIZIONE DESCRIPTION	SPECIFICHE SPECIFICATIONS	CODICE ARTICOLO ARTICLE CODE	MISURA SIZE (mm)	Pz/Conf Pcs/ Box	PREZZO PRICE (€)	
*Tubo scarico condensa corrugato	In polipropilene bianco	SCARICOND18	Ø INT: 16 Ø EXT: 18 Rotolo da 50 m	1	49,80	
*Corrugated condensate drain pipe	White Polypropylene	SCARICOND20	Ø INT: 18 Ø EXT: 20 Rotolo da 50 m	1	59,20	

* Con innesti Maschio/Femmina distanziati ad ogni metro - With Male/Female connections at 1 m range
Non sono necessari accessori - No accessories needed

Tubo corrugato -
dettaglio innesto

Corrugated pipe -
Connection detail





ACCESSORI PER CONDIZIONAMENTO ACCESSORIES FOR AIR CONDITIONING SYSTEMS





GROPPALLI
FLUE SYSTEMS
DISTRIBUZIONE

NASTRI CONDIZIONAMENTO CONDITIONING TAPES

ACCESSORI
CONDIZIONAMENTO
ACCESSORIES FOR
CONDITIONING
SYSTEMS

DESCRIZIONE DESCRIPTION	SPECIFICHE SPECIFICATIONS	CODICE ARTICOLO ARTICLE CODE	MISURA SIZE (mm)	Pz/Conf Pcs/ Box	PREZZO PRICE UNIT (€)	
Tape anticondensa nero <i>Black anti- condensate tape</i>	Gomma espansa Alta densità Retato <i>Elastomeric foam High density Netted</i>	TAPANTICOND-BL	50 x 3 L = 10 m	24	5,08	
Tape in alluminio <i>Aluminium tape</i>	Alluminio <i>Aluminium</i>	TAPALU-50	50 L = 50 m	24	9,80	
Tape anticondensa nero rivestito in alluminio <i>Black anticondensation tape</i>	Gomma espansa nera rivestita con alluminio <i>Black elastomeric foam aluminium coated</i>	TAPANTICOND-ALU	50 x 3 L = 10 m	24	8,05	

VASCHETTA RECUPERO CONDENSA CONDENSATE BOX

DESCRIZIONE DESCRIPTION	SPECIFICHE SPECIFICATIONS	CODICE ARTICOLO ARTICLE CODE	MISURA SIZE (mm)	Pz/Conf Pcs/ Box	PREZZO PRICE (€)	
Vaschetta recupero condensa <i>Condensate box</i>	In polipropilene bianco seta Scarico laterale <i>Silk-white polypropylene Lateral discharge</i>	VASCHETTACOND04	430 x 65 x 108	20	8,30	
Vaschetta recupero condensa con sifone <i>Condensate box with siphon</i>	Uscita di scarico reversibile Completa di viti per fissaggio <i>Reversible exhaust outlet complete with screws for fixing</i>	VASCHETTA-SIFONTEK	430 x 65 x 108	16	22,61	
Pipetta di scarico condensa con tappi <i>Discharge pipette condensation with caps</i>	Chiusura elastica a pressione PVC	PIPETEK-19	Ø 19	10	3,22	
	PVC Elastic pressure closure	PIPETEK-32	Ø 32	10	4,41	

ACCESSORI PER CONDIZIONAMENTO ACCESSORIES FOR AIR CONDITIONING SYSTEMS



GROPPALLI
FLUE SYSTEMS
DISTRIBUZIONE

DESCRIZIONE DESCRIPTION	SPECIFICHE SPECIFICATIONS	CODICE ARTICOLO ARTICLE CODE	MISURA SIZE (Pollici - Inch)	Pz/Conf Pcs/ Box	PREZZO PRICE UNIT (€)	
Curva 90° maschio/maschio 90° elbow male/male	Ottone Brass	CURVA90-14	1/4	10	3,18	
		CURVA90-38	3/8	10	3,85	
		CURVA90-12	1/2	10	6,60	
		CURVA90-58	5/8	10	9,21	
Tappo cieco femmina Female cap	Ottone Brass	TAPPOCIECO-14	1/4	10	0,81	
		TAPPOCIECO-38	3/8	10	1,77	
		TAPPOCIECO-12	1/2	10	1,84	
		TAPPOCIECO-58	5/8	10	3,29	
Guarnizione conica Conical gasket	Rame Copper	GUARNIZIONE-14	1/4	10	0,12	
		GUARNIZIONE-38	3/8	10	0,24	
		GUARNIZIONE-12	1/2	10	0,28	
		GUARNIZIONE-58	5/8	10	0,36	
Raccordo ad inversione Reversed fittings	Rame Copper	INVERSIONE-14	1/4	10	8,51	
		INVERSIONE-38	3/8	10	12,00	
		INVERSIONE-12	1/2	5	14,50	
Sbavatore per tubi in PVC, PPR, rame, ottone e alluminio Tube reamer for PVC, PPR, copper, brass and aluminium tubes	Corpo in PVC Lame in acciaio PVC body Steel blades	SVASORIGID	da 3/16" a 1-1/2" (5-32 mm)	1	3,56	 NEW
Mini tagliatubi per tubi in rame, ottone, alluminio ed acciaio Mini tube cutter for copper, brass, aluminium and stainless steel tubes	Acciaio Stainless steel	TAGLIAMETAL	da 1/8" a 7/8" (3-22 mm)	1	4,84	 NEW
Cartellatrice eccentrica manuale universale Eccentric manual flaring tool	Acciaio Stainless steel	CARTELLARIGID	da 3/16" a 3/4" (5-19 mm)	1	37,84	 NEW

**ACCESSORI
CONDIZIONAMENTO**
ACCESSORIES FOR
CONDITIONING
SYSTEMS



GROPPALLI
FLUE SYSTEMS
DISTRIBUZIONE

POMPE PER SCARICO

CONDENSA





CONDENSATE DRAIN

PUMPS



POMPE SCARICO CONDENSA CONDENSATE DRAIN PUMPS

POMPE SCARICO CONDENSA CONDENSATE DRAIN PUMPS

DESCRIZIONE DESCRIPTION	SPECIFICHE SPECIFICATION	CODICE ARTICOLO ARTICLE CODE	PREZZO PRICE (€)	
<p>Pompa scarico condensa a pistone con galleggiante. Climatizzatori fino a 20 kw</p> <p><i>Piston condensate drain pump with floating. Max 20 kw air conditioning</i></p>	<p>Portata massima: 20 L/h Altezza di spinta massima: 10 m Altezza aspirazione massima: 3 m Livello sonoro: 20 dBA Fattore di servizio: 100% Allarme incluso</p> <p><i>Flowrate max: 20 L/h Discharge head max: 10 m Suction head max : 3 m Sound level: 20 dBA Operating cycle: 100% Alarm included</i></p>	<p>CONDIPUMP</p> <p>POMPA PER CONDIZIONATORI AIR CONDITIONER PUMP</p>		 <p>Dimensioni - Dimensions: 55 x 38 x 37,5 mm 66 x 43,5 x 60 mm</p>
<p>Pompa scarico condensa a pistone con serbatoio integrato</p> <p><i>Piston condensate drain pump with tank</i></p>	<p>Portata massima: 19 L/h Altezza di spinta massima: 10 m Allarme incluso</p> <p><i>Max Flowrate: 19 L/h Discharge head max: max: 10 m Alarm included</i></p>	<p>BOILPUMP-SC</p> <p>POMPA PER CALDAIE BOILERS PUMP</p>		 <p>NEW</p>
<p>Pompa scarico condensa a pistone con serbatoio integrato da 0,37 lt</p> <p><i>Piston condensate drain pump with 0,37 L tank</i></p>	<p>Portata massima: 10 L/h Altezza di spinta massima: 6 m Livello sonoro: < 28 dBA Allarme incluso</p> <p><i>Max Flowrate: 10l/h Disch.head max.:6mt Sound level: < 28dBA Alarm included</i></p>	<p>BOILPUMP-B</p> <p>POMPA PER CALDAIE BOILERS PUMP</p>		 <p>Dimensioni - Dimensions: 168 x 90 x 88 mm</p>
<p>Tubo scarico condensa trasparente</p> <p><i>Transparent condensate drain pipe</i></p>	<p>Rotolo 25 m ØINT: 6 mm ØEST: 9 mm</p> <p><i>25 m roll ØINT: 6mm ØEXT: 9 mm</i></p>	TUBOPVC-25M	23,63	

CONTATTATECI PER AVERE I PREZZI - ASK FOR PRICES



GROPPALLI
FLUE SYSTEMS
DISTRIBUZIONE

VENTILAZIONE MECCANICA CONTROLLATA

CONTROLLED MECHANICAL VENTILATION

UNITA' DI VENTILAZIONE
UNITA' DI VENTILAZIONE CON DEUMIDIFICAZIONE
DISTRIBUTORI PLENUM
BOCCHETTE E GRIGLIE
CONDOTTI FLESSIBILI
ACCESSORI PER LA VMC

VENTILATION UNITS
VENTILATION UNITS WITH DEHUMIDIFICATION
BOXES AND GRIDS
FLEXIBLE PIPES
INSULATED PIPES
CMV ACCESSORIES

Progetti su misura

Partendo dalla planimetria dell'abitazione studieremo il progetto che più si adegua alle vostre necessità. L'unione dell'elevata qualità dei materiali offerti nei nostri sistemi, di un accurato studio e di una progettazione su misura rende gli impianti di Ventilazione Meccanica Controllata VMC GROPPALLI una valida opzione di installazione nell'ottica del miglioramento della vita quotidiana, della casa e del benessere di chi ci vive. Il sistema di VMC filtrerà costantemente l'aria esterna prima di introdurla nell'abitazione per impedire l'ingresso a particelle di polvere, pollini, sgradevoli odori ed agenti inquinanti in generale, riducendo così sensibilmente la formazione di muffe ed umidità. Inoltre, sarà possibile mitigare la temperatura dell'aria in ingresso, sia nel periodo invernale che in quello estivo, riducendo i costi dell'energia per il riscaldamento o per il raffrescamento degli ambienti.

Custom Made

Groppalli's staff will provide you the project of CMV which best fits your needs, starting from your house's Layout. Thanks to the high quality of employed materials, the thorough study and a tailor-made planning, Groppalli's CMV systems are an efficient installation option in order to improve everyday life and occupants' Wellbeing. CMV system will filter the outdoor air before letting it in to prevent the entrance of dust, particulate matter, pollen, polluting agents or unpleasant smells. It will reduce mould growth and the formation of moisture on walls. In addition, the system will mitigate air inlet temperature, both in winter and in summer, reducing energy costs for room heating and cooling.

UNITÀ DI VENTILAZIONE

VENTILATION UNIT

180-UNIVENT-BB

180E-UNIVENT-BB (entalpico)

GROPPALLI
VMC
DISTRIBUZIONE



UNITÀ DI RECUPERO CALORE DOMESTICA CENTRALIZZATA AD ALTISSIMA EFFICIENZA
REGOLAZIONE PLUG AND PLAY WIRELESS INCLUSA
BY-PASS AUTOMATICO INCLUSO
INSTALLAZIONE ORIZZONTALE-VERTICALE-DESTRA-SINISTRA
 Recuperatore di calore: in controcorrente interamente realizzato in materiale plastico.
 Struttura: autoportante in PPE a tenuta completa di sistema estrazione filtri e drenaggio condensa.
 Ventilatori: plug fan con motore EC Brushless a semplice aspirazione.
 Filtri: le unità sono provviste di serie con celle filtranti ondulate in fibra sintetica classe G4, in opzione filtro efficienza F7 su aria esterna.

Installazione verticale e orizzontale
Vertical and horizontal installation



DOMESTIC CENTRALIZED HEAT RECOVERY UNIT WITH VERY HIGH EFFICIENCY
WITH WIRELESS PLUG AND PLAY CONTROL SYSTEM INCLUDED
AUTOMATIC BY-PASS INCLUDED
HORIZONTAL-VERTICAL-RIGHT-LEFT INSTALLATION
 Heat recovery: heat exchanger of the type in countercurrent entirely made of plastic material.
 Structure: free standing EPP seal, complete of filters extraction system and drain condensate.
 Fans: plug fan with EC Brushless engine single inlet.
 Filters: the units are equipped with standard filter cells synthetic fiber efficiency G4, optional F7 efficiency on fresh air.

Prezzo - Price

180-UNIVENT-BB 2.219,00 €

180E-UNIVENT-BB 2.577,75 €
 Con scambiatore entalpico
 With enthalpy exchanger

Vista dal basso | Bottom View

Vista interna | Internal view

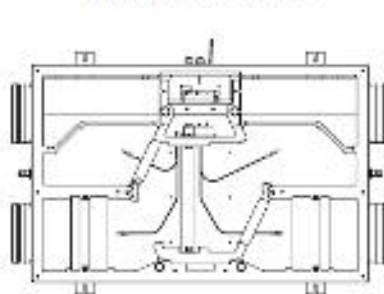

Vista laterale | Side view



Vista in pianta | Plan view

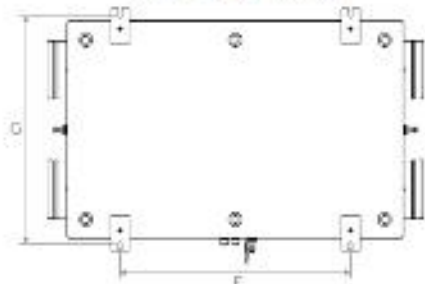

Portata aria (mc/h) Nominal air flow (mc/h)	180
Pressione statica utile (pa) Useful static pressure (pa)	100
DATI PER SINGOLO VENTILATORE DATA FOR EACH FAN	
Potenza nominale (W) Installed power (W)	27
Giri (l/min) Round (l/min)	3700
I nominale (A) Current (A)	0.27
Tensione (V) Rated voltage (V)	230
Frequenza (Hz) Frequency (Hz)	50
Velocità (nr) Speed (nr)	3+(1 booster)
FILTRI FILTERS	
Efficienza Efficiency Standard	G4 ISO G4ARSE > 65 %
Efficienza Efficiency Optional	F7 ISO e PM1 > 65 %

Dimensioni - Dimensions

	A	B	C	D	ØE	F	G	H	I	K
mm	125	580	260	320	156	617	609	900	1005	268

UNITÀ DI VENTILAZIONE

VENTILATION UNIT

250-UNIVENT-BB

250E-UNIVENT-BB (entalpico)



**UNITÀ DI RECUPERO CALORE DOMESTICA CENTRALIZZATA AD ALTISSIMA EFFICIENZA
REGOLAZIONE PLUG AND PLAY WIRELESS INCLUSA
BY-PASS AUTOMATICO INCLUSO
INSTALLAZIONE ORIZZONTALE-VERTICALE-DESTRA-SINISTRA**

Recuperatore di calore: in controcorrente interamente realizzato in materiale plastico.
Struttura: autoportante in PPE a tenuta completa di sistema estrazione filtri e drenaggio condensa.

Ventilatori: plug fan con motore EC Brushless a semplice aspirazione.

Filtri: le unità sono provviste di serie con celle filtranti ondulate in fibra sintetica classe G4, in opzione filtro efficienza F7 su aria esterna.

**DOMESTIC CENTRALIZED HEAT RECOVERY UNIT WITH VERY HIGH EFFICIENCY AND WITH WIRELESS PLUG AND PLAY CONTROL SYSTEM INCLUDED
AUTOMATIC BY-PASS INCLUDED**

HORIZONTAL-VERTICAL-RIGHT-LEFT INSTALLATION

Heat recovery: heat exchanger of the type in countercurrent entirely made of plastic material.

Structure: free standing EPP seal, complete of filters extraction system and drain condensate.

Fans: plug fan with EC Brushless engine single inlet.

Filters: the units are equipped with standard filter cells synthetic fiber efficiency G4, optional F7 efficiency on fresh air.

Installazione verticale e orizzontale
Vertical and horizontal installation

Vista dal basso | Bottom View

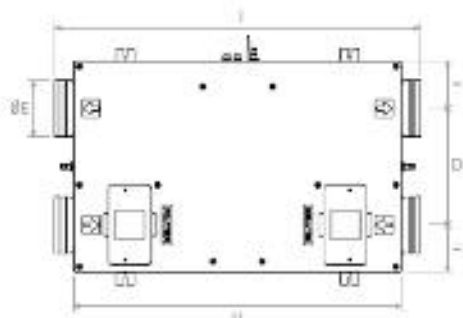

Vista laterale | Side view

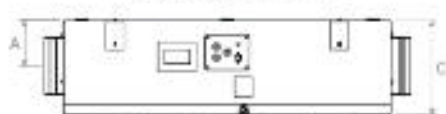

Vista In pianta | Plan view

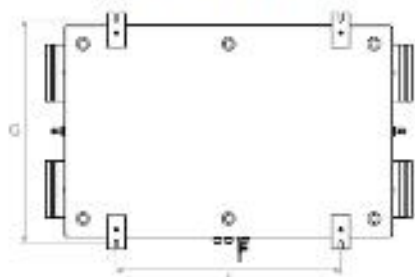

Vista interna | Internal view

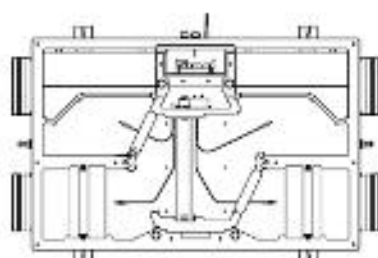

Prezzo - Price

250-UNIVENT-BB 2.362,85 €

250E-UNIVENT-BB 2.719,50 €

Con scambiatore entalpico
With enthalpy exchanger

Portata aria (mc/h) Nominal air flow (mc/h)	250
Pressione statica utile (pa) Useful static pressure (pa)	100

DATI PER SINGOLO VENTILATORE | DATA FOR EACH FAN

Potenza nominale (w) Installed power (W)	50
Giri (1/min) Round (1/MIN)	4320
I nominale (A) Current (A)	0,46
Tensione (V) Rated voltage (V)	230
Frequenza (Hz) Frequency (HZ)	50
Velocità (nr) Speed (nr)	3+(1 booster)

FILTRI | FILTERS

Efficienza Efficiency Standard	G4 ISO COARSE > 65 %
Efficienza Efficiency Optional	F7 ISO e PM1 > 65 %

Dimensioni - Dimensions

	A	B	C	D	ØE	F	G	H	I	K
mm	125	580	260	320	156	617	609	900	1005	268

UNITÀ DI VENTILAZIONE

VENTILATION UNIT

320-UNIVENT-BB

GROPPALLI
VMC
DISTRIBUZIONE



Installazione verticale e orizzontale
Vertical and horizontal installation

UNITÀ DI RECUPERO CALORE DOMESTICA CENTRALIZZATA AD ALTISSIMA EFFICIENZA
REGOLAZIONE PLUG AND PLAY WIRELESS INCLUSA
BY-PASS AUTOMATICO INCLUSO
INSTALLAZIONE ORIZZONTALE-VERTICALE

Recuperatore di calore: in controcorrente interamente realizzato in materiale plastico.

Struttura: autoportante in PPE a tenuta completa di sistema di estrazione filtri e drenaggio condensa.

Ventilatori: plug fan con motore EC Brushless a semplice aspirazione.

Filtri: le unità sono provviste di serie con celle filtranti ondulate in fibra sintetica classe G4, in opzione filtro efficienza F7 su aria esterna.



Prezzo - Price

320-UNIVENT-BB

2.901,50 €

DOMESTIC CENTRALIZED HEAT RECOVERY UNIT WITH VERY HIGH EFFICIENCY AND WITH WIRELESS PLUG AND PLAY CONTROL SYSTEM INCLUDED
AUTOMATIC BY-PASS INCLUDED
HORIZONTAL-VERTICAL INSTALLATION

Heat recovery: heat exchanger of the type in countercurrent entirely made of plastic material.

Structure: free standing EPP seal, complete of filter extraction system and drain condensate.

Fans: plug fan with EC Brushless engine single inlet.

Filters: the units are equipped with standard filter cells synthetic fiber efficiency G4, optional F7 efficiency on fresh air.

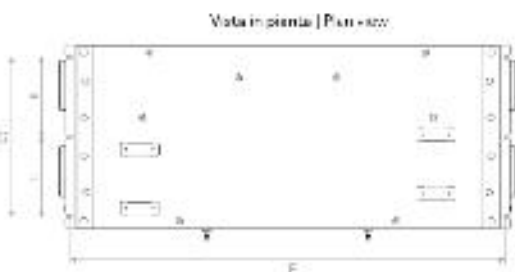
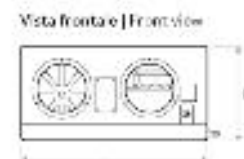
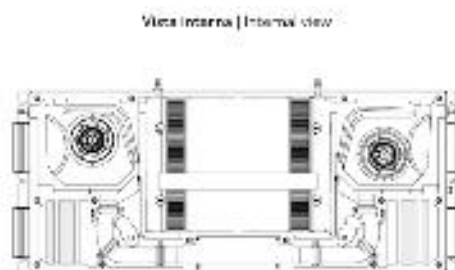
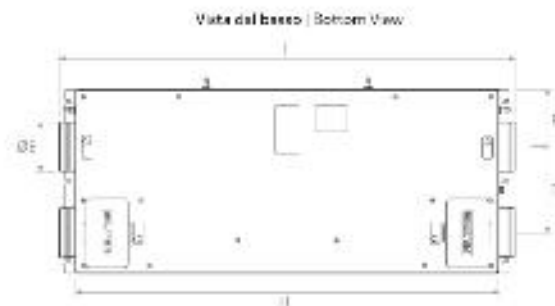

Portata aria (mc/h) Nominal air flow (mc/h)	320
Pressione statica utile (pa) Useful static pressure (pa)	100

DATI PER SINGOLO VENTILATORE | DATA FOR EACH FAN

Potenza nominale (w) Installed power (W)	83
Giri (1/min) Round (1/MIN)	3200
I nominale (A) Current (A)	0,75
Tensione (V) Rated voltage (V)	230
Frequenza (Hz) Frequency (HZ)	50
Velocità (nr) Speed (nr)	3+(1 booster)

FILTRI | FILTERS

Efficienza Efficiency Standard	G4 ISO COA/SE > 65 %
Efficienza Efficiency Optional	F7 ISO e FM1 > 65 %

Dimensioni - Dimensions

	A	B	C	D	ØE	F	G	H	I	K	P
mm	129	578	277	271	166	1367	600	1330	1431	291	180

UNITÀ DI VENTILAZIONE

VENTILATION UNIT

450-UNIVENT-BB

450E-UNIVENT-BB (entalpico)

GROPPALLI
VMC
DISTRIBUZIONE



Installazione verticale e orizzontale
Vertical and horizontal installation



UNITÀ DI RECUPERO CALORE DOMESTICA CENTRALIZZATA AD ALTISSIMA EFFICIENZA
REGOLAZIONE PLUG AND PLAY WIRELESS INCLUSA
BY-PASS AUTOMATICO INCLUSA
INSTALLAZIONE ORIZZONTALE-VERTICALE

Recuperatore di calore: in controcorrente interamente realizzato in materiale plastico.

Struttura: autoportante in PPE a tenuta completa di sistema di estrazione filtri e drenaggio condensa.

Ventilatori: plug fan con motore EC Brushless a semplice aspirazione.

Filtri: le unità sono provviste di serie con celle filtranti ondulate in fibra sintetica classe G4, in opzione filtro efficienza F7 su aria esterna.

DOMESTIC CENTRALIZED HEAT RECOVERY UNIT WITH VERY HIGH EFFICIENCY AND WITH WIRELESS PLUG AND PLAY CONTROL SYSTEM INCLUDED
AUTOMATIC BY-PASS INCLUDED
HORIZONTAL-VERTICAL INSTALLATION

Heat recovery: heat exchanger of the type in countercurrent entirely made of plastic material.

Structure: free standing EPP seal, complete of filter extraction system and drain condensate.

Fans: plug fan with EC Brushless engine single inlet.

Filters: the units are equipped with standard filter cells synthetic fiber efficiency G4, optional F7 efficiency on fresh air.

Prezzo - Price

450-UNIVENT-BB 3.167,50 €

450E-UNIVENT-BB 4.158,00 €

Con scambiatore entalpico
With enthalpy exchanger

Vista dal basso | Bottom view

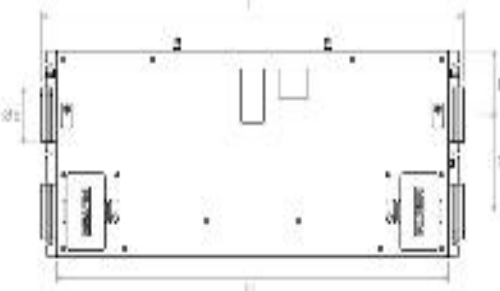

Vista interna | Internal view

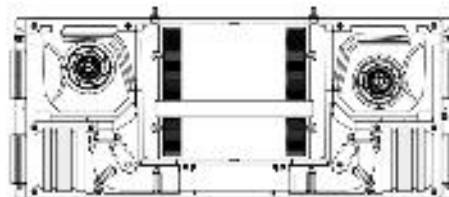

Vista frontale | Front view

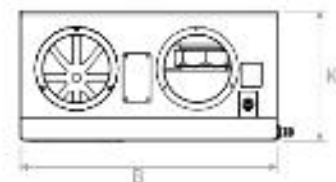

Vista laterale | Side view



Vista in planta | Plan view

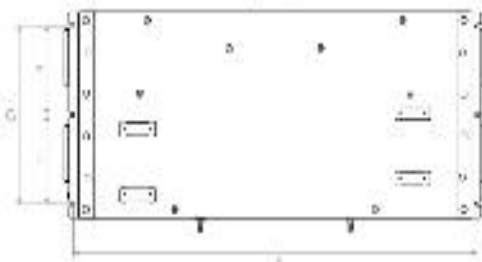

Portata aria (mc/h) | Nominal air flow (mc/h) 450

Pressione statica utile (PA) | Useful static pressure (PA) 100

DATI PER SINGOLO VENTILATORE | DATA FOR EACH FAN

Potenza nominale (w) | Installed power (W) 169

Giri (1/min) | Round (1/MIN) 4120

I nominale (A) | Current (A) 1,35

Tensione (V) | Rated voltage (V) 230

Frequenza (Hz) | Frequency (Hz) 50

Velocità (nr) | Speed (nr) 3 (1 booster)

FILTRI | FILTERS

Efficienza | Efficiency Standard G4 ISO COARSE > 65%

Efficienza | Efficiency Optional F7 ISO e PM1 > 65%

Dimensioni - Dimensions

	A	B	C	D	ØE	F	G	H	I	K	P
mm	129	578	277	271	166	1367	500	1330	1431	291	180

UNITÀ DI VENTILAZIONE VENTILATION UNIT

LEVANTE

NEW

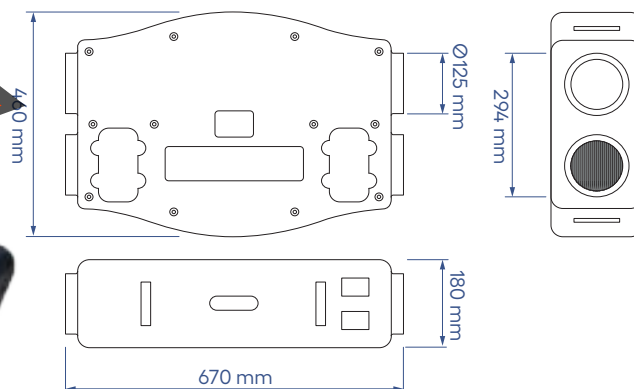

- Portata d'aria: fino a **150 m³/h**
- Pressione statica: **450 Pa**
- Peso: **5,5 Kg**
- Potenza W: **2x28w**
- Tensione di esercizio: **184-276 VCA**
- Perdita di carico dell'aria: **33,56 Pa**
- Efficienza: **94%**

Unità di ventilazione meccanica a doppio flusso canalizzata con recupero di calore ad alta efficienza, progettata per l'uso in contesti residenziali, specialmente indicata per la ristrutturazione di abitazioni, installabile sia a soffitto che a parete. Dispone di 4 connessioni da Ø125 per il collegamento dei tubi di distribuzione dell'aria. L'unità include uno scarico integrato per l'evacuazione della condensa. Struttura realizzata in polipropilene espanso (EPP). Dotata di due filtri F7

Altre caratteristiche:

- Unità di ventilazione meccanica controllata (VMC) a doppio flusso.
- Installazione verticale o orizzontale.
- Recuperatore di calore a flussi incrociati.
- Corpo in EPP garantisce l'isolamento termico e acustico, peso ridotto.
- Potenziometro integrato nel unità per variare la velocità dei ventilatori.
- By Pass (Solamente nel modello LEVANTE TOPSF)
- Sensore igrostatato (Solamente nel modello LEVANTE TOPSF)
- Pannello di controllo cablato (Solamente nel modello LEVANTE TOPSF)
- Sensori per la sostituzione dei filtri (Solamente nel modello LEVANTE TOPSF)

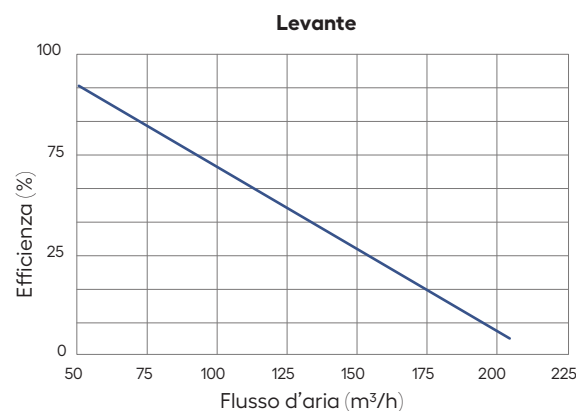

*Pannello di controllo cablato
(Compreso solo nel modello
LEVANTE TOPSF)

Due versioni disponibili:

LEVANTE TOPSF **1.925,00€**
Con potenziometro esterno cablato e sonde per la pulizia del filtro

LEVANTE BASIC **1.662,50€**
Senza potenziometro ne sonde per pulizia del filtro

UNITÀ DI VENTILAZIONE VENTILATION UNIT

220-UNIVENT-BB 220E-UNIVENT-BB (entalpico)



Solo installazione verticale
Only vertical installation

**UNITÀ DI RECUPERO CALORE DOMESTICA CENTRALIZZATA AD ALTISSIMA EFFICIENZA
REGOLAZIONE PLUG AND PLAY WIRELESS INCLUSA
BY-PASS AUTOMATICO INCLUSO**

Recuperatore di calore: in controcorrente interamente realizzato in materiale plastico.

Struttura: autoportante: in EPS a tenuta con mantello esterno in acciaio completa di sistema estrazione filtri e drenaggio condensa.

Ventilatori: plug fan con motori EC Brushless.

Filtri: le unità sono provviste di serie con celle filtranti ondulate in fibra sintetica classe G4, in opzione filtro efficienza F7 su aria esterna.

**DOMESTIC CENTRALIZED HEAT RECOVERY UNIT WITH VERY HIGH EFFICIENCY AND WITH
WIRELESS PLUG AND PLAY CONTROL SYSTEM INCLUDED
AUTOMATIC BY-PASS INCLUDED**

Heat recovery: heat exchanger of the type in countercurrent entirely made of plastic material.

Structure: free standing EPS seal with outer coat painted steel complete of filters extraction system and drain condensate.

Fans: plug fan type with EC Brushless engine.

Filters: the units are equipped with standard filter cells synthetic fiber efficiency G4, optional F7 efficiency on fresh air.

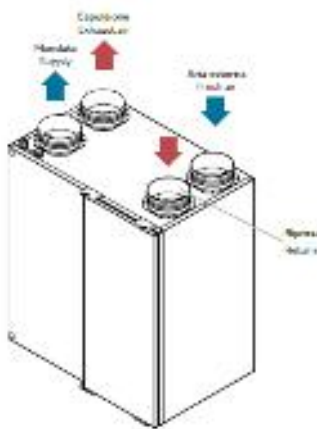

Vieta frontale | Front view

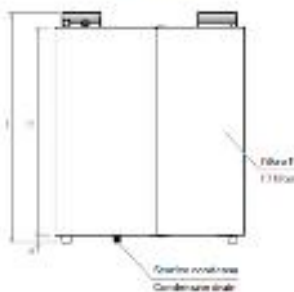

Vieta superiore | Top view

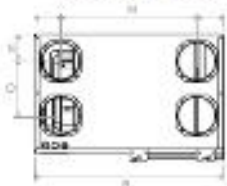

Vieta laterale | Side view



Portata aria (mc/h) Nominal air flow (mc/h)	220
Pressione statica utile (pa) Useful static pressure (pa)	100

VENTILATORE DIRETTAMENTE ACCOPPIATO | FANS (DATA FOR EACH FAN)

Potenza nominale (w) Installed power (W)	56
I nominale (A) Current (A)	0,41
Tensione (V) Rated voltage (V)	230
Frequenza (Hz) Frequency (HZ)	50
Velocità (nr) Speed (nr)	3 = (1 booster)

FILTRI | FILTERS

Efficienza Efficiency Standard	G4 ISO COARSE > 85 %
Efficienza Efficiency Optional	F7 ISO e PM10 > 85 %

Dimensioni - Dimensions

	B	C	H	ØE	I	M	O	R	S
mm	600	400	660	123	722	427	172	24	87

Prezzo - Price

220-UNIVENT-BB 2.901,50 €

220E-UNIVENT-BB 4.025,25 €

Con scambiatore entalpico
With enthalpy exchanger



UNITÀ DI VENTILAZIONE CON DEUMIDIFICAZIONE VENTILATION UNIT WITH DEHUMIDIFICATION

300-DEUNIVENT-BB

Altre potenze disponibili su richiesta
Other models available on demand

**UNITÀ DI VENTILAZIONE MECCANICA CONTROLLATA
CENTRALIZZATA AD ALTISSIMA EFFICIENZA CON SISTEMA DI
DEUMIDIFICAZIONE INTEGRATO
FUNZIONE DI VENTILAZIONE CON RECUPERO ENTALPICO
FUNZIONE DI DEUMIDIFICAZIONE E/O INTEGRAZIONE
FUNZIONE FREE-COOLING**

FUNZIONE CONTROLLO CLIMATICO: Controllo della temperatura di immissione in fase di deumidificazione e contestuale miglioramento della resa frigorifera e del livello acustico associato.

Recuperatore di calore: in controcorrente entalpico interamente realizzato in materiale plastico.

Struttura: autoportante in acciaio preverniciato con isolamento termoacustico.

Ventilatori: plug fan con motore EC Brushless.

Filtri: le unità sono provviste di serie di celle filtranti efficienza G4. Batteria di pre-raffrescamento/ riscaldamento: (acqua-aria) con tubo alettato in rame ed alette in alluminio completa di valvola a 3 vie.

Batteria evaporante: (gas-aria) con tubo alettato in rame ed alette in alluminio.

Batteria condensante: (gas-aria) con tubo alettato in rame ed alette in alluminio. Scambiatore condensante a piastre: (acqua-gas) saldobrasato completo di valvola deviatrice e 3 vie modulante dedicata al controllo della massima resa frigorifera e del controllo della temperatura di mandata dell'aria.

Compressore: ermetico alternativo (R134A). Serranda di free-cooling: (completa di servomotore).

Serranda di ricircolo: (completa di servomotore).

Controlli: CONTROL-DEUNISONDA-BB: controllo per settaggio unità con sonda umidità inclusa. è tassativamente necessario la valutazione positiva del consulente termotecnico. Unità funzionante solo con adduzione di acqua refrigerata. Optional vivamente

Consigliato: circuito idronico di acqua refrigerata dedicato.

**HIGH EFFICIENCY CENTRALIZED CONTROLLED MECHANICAL VENTILATION UNIT WITH
INTEGRATED DEHUMIDIFICATION SYSTEM
VENTILATION FUNCTION WITH ENTHALPIC ENERGY RECOVERY DEUMIFICATION AND / OR INTEGRATION FUNCTION
FREE-COOLING FUNCTION**

FUNCTION CLIMATE CONTROL: Control of supply air temperature during the dehumidification phase and contextual improvement of the cooling performance and associated noise level.

Recovery heat exchanger: Enthalpic counter-current entirely made of plastic material.

Structure: self-supporting structure in pre-painted steel with thermal and acoustic insulation.

Fans: plug fan with EC Brushless motor.

Filters: the units are equipped as standard with G4 efficiency filter cells. Pre-cooling / heating coil: (water-air) with finned copper tube and aluminum fins complete with 3-way valve.

Evaporating coil: (gas-air) with finned copper tube and aluminum fins.

Condensing coil: (gas-air) with finned copper tube and aluminum fins. Brazed plate heat exchanger:

(water-gas) complete with 3 way diverter modulating control valve dedicated to the control of maximum refrigeration efficiency and air delivery temperature. Compressor: alternative hermetic (R134A).

Free-cooling damper: (complete with servomotor).

Recirculating damper: (complete with servomotor).

Controls: CONTROL-DEUNISONDA-BB: unit setting control with humidity probe included. In the case of only control the positive evaluation of the thermotechnical consultant is imperative. Unit operating only with chilled water supply. Dedicated hydronic chilled water circuit is highly **recommended**.

UNITÀ DI VENTILAZIONE CON DEUMIDIFICAZIONE VENTILATION UNIT WITH DEHUMIDICATION

GROPPALLI
VMC
DISTRIBUZIONE



mm	B	C	H	E	P	F	G	I	K
	800	254	803	155	155	538	832	905	250

Prezzo - Price

300-DEUNIVENT-BB

7.577,50 €

RENDIMENTO INVERNALE DEL RECUPERATORE | WINTER EFFICIENCY OF THE HEAT EXCHANGER

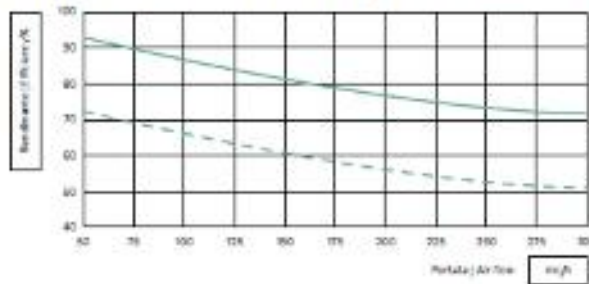

Temperatura - Rendimento recuperatore alle condizioni esterne di 20°C/20°C ed interne di 20°C/20°C (SN 13941-220)
 Temperature - Efficiency heat exchanger from air 20°C/20°C return air 20°C/20°C (SN 13941-220)
 Temperatura - Rendimento recuperatore alle condizioni esterne di 20°C/20°C ed interne di 20°C/15°C (SN 13941-220)
 Humidity - efficiency heat exchanger from air 20°C/20°C return air 20°C/15°C (SN 13941-220)

ASSORBIMENTI ELETTRICI | POWER CONSUMPTION

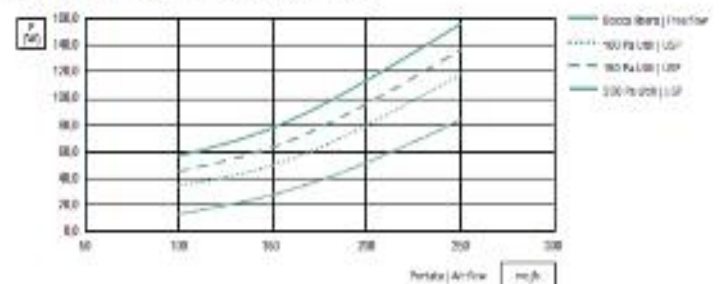

RENDIMENTO ESTIVO DEL RECUPERATORE | SUMMER EFFICIENCY OF THE HEAT EXCHANGER

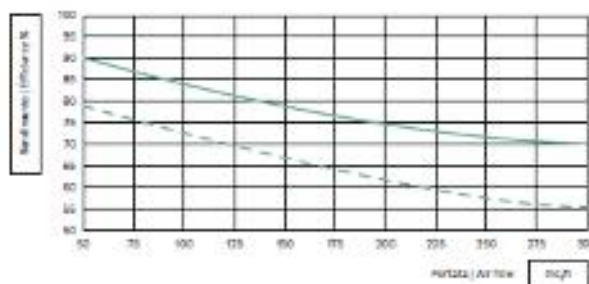

Temperatura - Rendimento recuperatore alle condizioni esterne di 20°C/20°C ed interne di 20°C/20°C (SN 13941-220)
 Temperature - Efficiency heat exchanger from air 20°C/20°C return air 20°C/20°C (SN 13941-220)
 Temperatura - Rendimento recuperatore alle condizioni esterne di 20°C/20°C ed interne di 20°C/15°C (SN 13941-220)
 Humidity - efficiency heat exchanger from air 20°C/20°C return air 20°C/15°C (SN 13941-220)

PREVALENZA UTILE IN VENTILAZIONE | USEFUL STATIC PRESSURE IN VENTILATION MODE

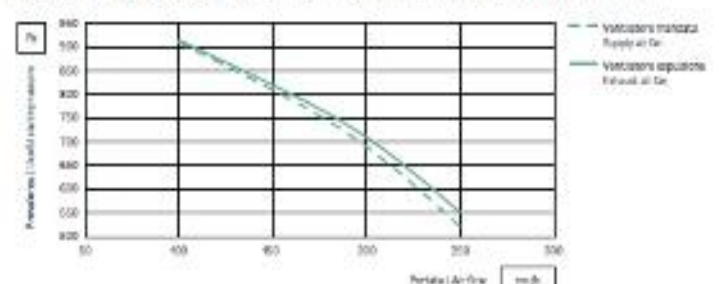

LIMITI FUNZIONAMENTO | OPERATING LIMITATIONS

Ventilazione (rinnovo d'aria): portata d'aria compresa tra 135 a 250 m³/h (per valori superiori contattare il costruttore)

Integrazione e/o deumidificazione: portata d'aria compresa tra 170 a 500 m³/h (tutti in ricircolo ambiente se non è attivo il rinnovo d'aria, miscela tra ricircolo ambiente ed aria esterna se il rinnovo è attivo)

Temperatura dell'acqua refrigerata: compresa tra i 10°C ed i 21°C

Portata dell'acqua: superiore ai 250 l/h

Ventilation (air renewal): air flow rate between 135-250 m³/h (contact the manufacturer for higher levels).

Integration and/or dehumidification: air flow rate between 170-500 m³/h (all in room recirculation if air renewal is not active; mix between Room recirculation and fresh air if renewal is active).

Chilled water temperature: between 10°C and 21°C.

Water flow rate: higher than 250 l/h.



NEW

UNITÀ DI VENTILAZIONE CON DEUMIDIFICAZIONE VENTILATION UNIT WITH DEHUMIDIFICATION

500-DEUNIVENT-BB

Altre potenze disponibili su richiesta
Other models available on demand



**UNITÀ DI VENTILAZIONE MECCANICA CONTROLLATA
CENTRALIZZATA AD ALTISSIMA EFFICIENZA CON SISTEMA DI
DEUMIDIFICAZIONE INTEGRATO**

FUNZIONE DI VENTILAZIONE CON RECUPERO ENTALPICO

FUNZIONE DI DEUMIDIFICAZIONE E/O INTEGRAZIONE

FUNZIONE FREE-COOLING

FUNZIONE CONTROLLO CLIMATICO: Controllo della temperatura di

immissione in fase di deumidificazione e contestuale miglioramento della resa frigorifera e del livello acustico associato.

Recuperatore di calore: in controcorrente entalpico interamente realizzato in materiale plastico.

Struttura: autoportante in acciaio preverniciato con isolamento termoacustico.

Ventilatori: plug fan con motore EC Brushless.

Filtri: le unità sono provviste di serie di celle filtranti efficienza G4. Batteria di pre-raffrescamento/ riscaldamento: (acqua-aria) con tubo alettato in rame ed alette in alluminio completa di valvola a 3 vie.

Batteria evaporante: (gas-aria) con tubo alettato in rame ed alette in alluminio.

Batteria condensante: (gas-aria) con tubo alettato in rame ed alette in alluminio. Scambiatore condensante a piastre: (acqua-gas) saldobrasato completo di valvola deviatrice e 3 vie modulante dedicata al controllo della massima resa frigorifera e del controllo della temperatura di mandata dell'aria.

Compressore: ermetico alternativo (R134A). Serranda di free-cooling: (completa di servomotore).

Serranda di ricircolo: (completa di servomotore).

Controlli: CONTROL-DEUNISONDA-BB : controllo per settaggio unità con sonda umidità inclusa, è tassativamente necessario la valutazione positiva del consulente termotecnico. Unità funzionante solo con adduzione di acqua refrigerata. Optional vivamente

Consigliato: circuito idronico di acqua refrigerata dedicato.

**HIGH EFFICIENCY CENTRALIZED CONTROLLED MECHANICAL VENTILATION UNIT WITH
INTEGRATED DEHUMIDIFICATION SYSTEM**

**VENTILATION FUNCTION WITH ENTHALPIC ENERGY RECOVERY DEUMIFICATION AND / OR INTEGRATION FUNCTION
FREE-COOLING FUNCTION**

FUNCTION CLIMATE CONTROL: Control of supply air temperature during the dehumidification phase and contextual improvement of the cooling performance and associated noise level.

Recovery heat exchanger: Enthalpic counter-current entirely made of plastic material.

Structure: self-supporting structure in pre-painted steel with thermal and acoustic insulation.

Fans: plug fan with EC Brushless motor.

Filters: the units are equipped as standard with G4 efficiency filter cells. Pre-cooling / heating coil: (water-air) with finned copper tube and aluminum fins complete with 3-way valve.

Evaporating coil: (gas-air) with finned copper tube and aluminum fins.

Condensing coil: (gas-air) with finned copper tube and aluminum fins. Brazed plate heat exchanger:

(water-gas) complete with 3 way diverter modulating control valve dedicated to the

control of maximum refrigeration efficiency and air delivery temperature. Compressor:

alternative hermetic (R134A).

Free-cooling damper: (complete with servomotor).

Recirculating damper: (complete with servomotor).

Controls: CONTROL-DEUNISONDA-BB: unit setting control with humidity probe included. the positive evaluation of the thermotechnical consultant is imperative. Unit operating only with chilled water supply. Dedicated hydronic chilled

water circuit is highly **recommended.**

UNITÀ DI VENTILAZIONE CON DEUMIDIFICAZIONE VENTILATION UNIT WITH DEHUMIDIFICATION

GROPPALLI
VMC
DISTRIBUZIONE



Vista dal basso | Bottom view

Vista interna | Internal view

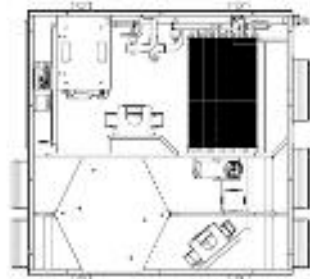
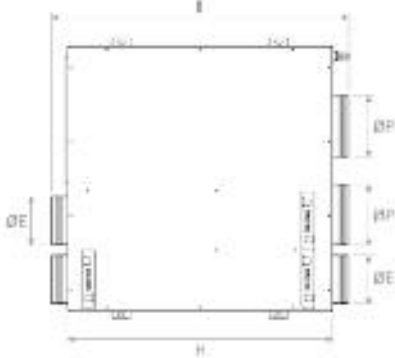

Prezzo - Price

500-DEUNIVENT-BB

10.570,00 €

Vista laterale | Side view

Vista frontale | Front view

Vista in pianta | Plan view

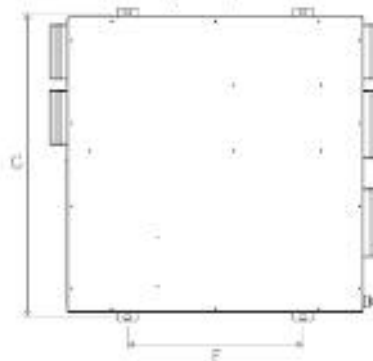
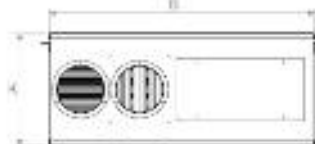

Dimensioni:

	B	C	H	E	P	F	G	I	K
mm	853	364	853	155	195	508	882	955	360

RENDIMENTO INVERNALE DEL RECUPERATORE | WINTER EFFICIENCY OF THE HEAT EXCHANGER

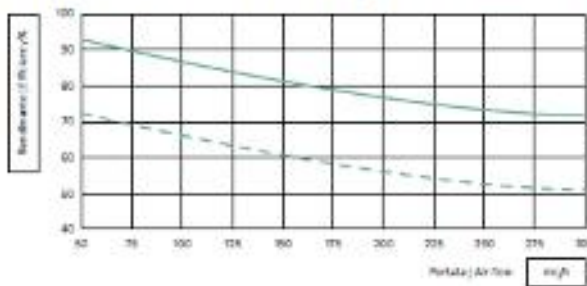

Temperatura - Rendimento recuperatore alle condizioni esterne di 7°C (25°F) e ritorno di 20°C (68°F) (EN 12441:2000)
Temperature - Efficiency heat exchanger from air 7°C (35°F) return air 20°C (68°F) (EN 12441:2000)
Umidità - Rendimento recuperatore alle condizioni esterne di 7°C (35°F) e ritorno di 20°C (68°F) (EN 12441:2000)
Humidity - efficiency heat exchanger from air 7°C (35°F) return air 20°C (68°F) (EN 12441:2000)

ASSORBIMENTI ELETTRICI | POWER CONSUMPTION

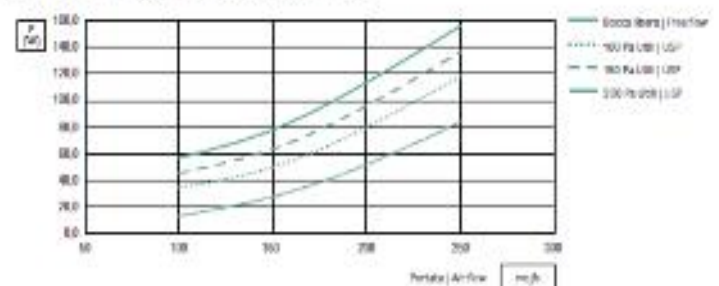

RENDIMENTO ESTIVO DEL RECUPERATORE | SUMMER EFFICIENCY OF THE HEAT EXCHANGER

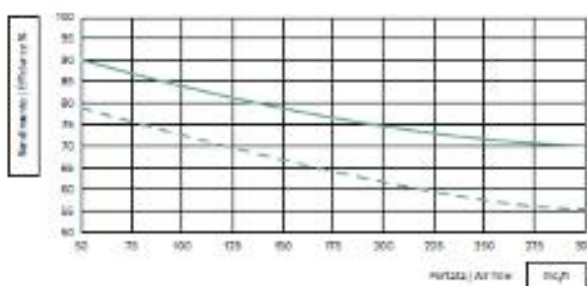

Temperatura - Rendimento recuperatore alle condizioni esterne di 27°C (81°F) e ritorno di 20°C (68°F) (EN 12441:2000)
Temperature - Efficiency heat exchanger from air 27°C (81°F) return air 20°C (68°F) (EN 12441:2000)
Umidità - Rendimento recuperatore alle condizioni esterne di 27°C (81°F) e ritorno di 20°C (68°F) (EN 12441:2000)
Humidity - efficiency heat exchanger from air 27°C (81°F) return air 20°C (68°F) (EN 12441:2000)

PREVALENZA UTILE IN VENTILAZIONE | USEFUL STATIC PRESSURE IN VENTILATION MODE

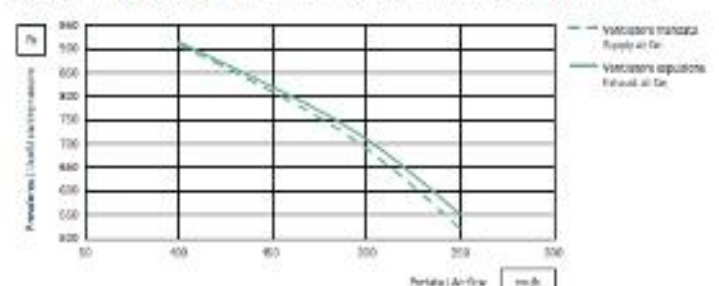

LIMITI FUNZIONAMENTO | OPERATING LIMITATIONS

Ventilazione (rinnovo d'aria): portata d'aria compresa tra 135 a 250 m³/h (per valori superiori contattare il costruttore)

Integrazione e/o deumidificazione: portata d'aria compresa tra 170 a 500 m³/h (tutti in ricircolo ambiente se non è attivo il rinnovo d'aria, miscela tra ricircolo ambiente ed aria esterna se il rinnovo è attivo)

Temperatura dell'acqua refrigerata: compresa tra i 10°C ed i 21°C

Portata dell'acqua: superiore ai 250 l/h

Ventilation (air renewal): air flow rate between 135-250 m³/h (contact the manufacturer for higher levels).

Integration and/or dehumidification: air flow rate between 170-500 m³/h (all in room recirculation if air renewal is not active; mix between Room recirculation and fresh air if renewal is active).

Chilled water temperature: between 10°C and 21°C.

Water flow rate: higher than 250 l/h.

ACCESSORI PER UNITÀ DI VENTILAZIONE UNITS ACCESSORIES



CONTROL-UNI-LCD-BB

Controller LCD per unità di ventilazione.
LCD controller for ventilation unit.

Non compatibile con il modello LEVANTE

262,50 €



CONTROL-DEUNISONDA-BB

Controller LCD per unità di ventilazione con deumidificazione.
Con sonda per rilevazione umidità.

*LCD controller for ventilation unit LCD controller for
ventilation units with dehumidification.*

With probe for humidity detection.

Non compatibile con il modello LEVANTE

617,75 €



CONTROL-UNI-APP-BB

Controller wireless da app per unità di ventilazione.
Wireless app controller for ventilation unit.

Non compatibile con il modello LEVANTE

360,26 €

BOCCHETTE BOX



Include:

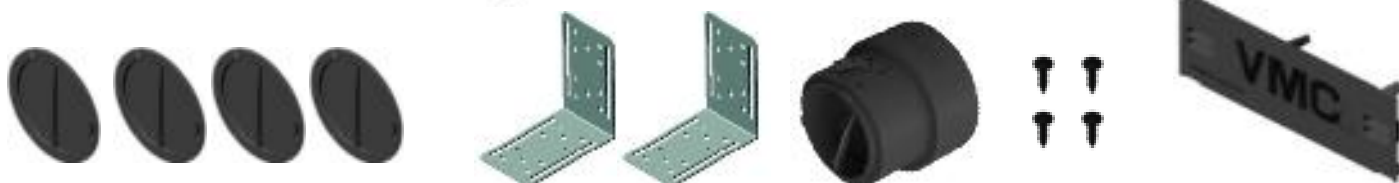

Descrizione: Bocchetta multifunzionale per terminali di distribuzione aria. Interamente realizzato in ABS consente la connessione con tubo in posizione posteriore, superiore o laterale. Completo di serrande di regolazione e di una ampia gamma di accessori per una installazione rapida e semplice.

Description: Multifunctional box for air distribution terminals. Made entirely of ABS allows the connection with hose in the rear, top or side position. Complete with control dampers and a large range of accessories for a quick and easy installation.

Codice - Code	Prezzo - Price
BOXPRE01-BB	47,78 €
BOXPRE03-BB* (TRIPLA)	79,42 €

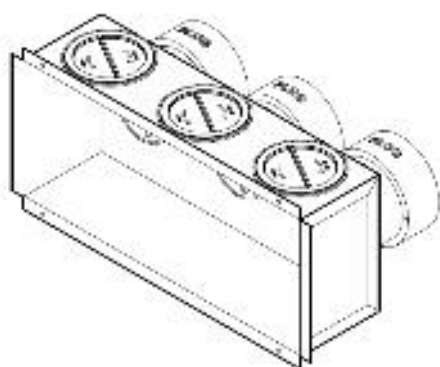

BOXPRE03-BB*

* 3 adattatori tubo flessibile compresi
3 flex adapters included



Codice - Code	Prezzo - Price
7590ADATBOX-BB (kit 5 pz)	46,20 €

Vista frontale | Front view

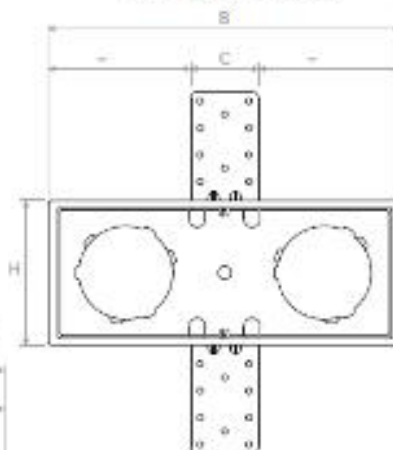

Vista laterale | Side view

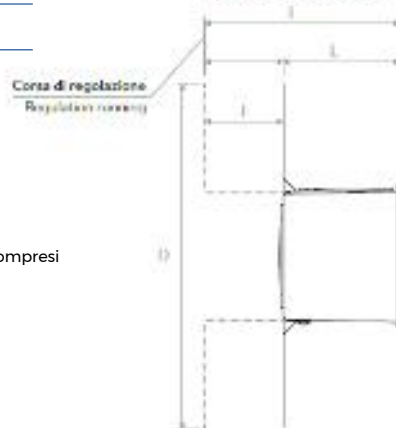

Vista superiore | Top view

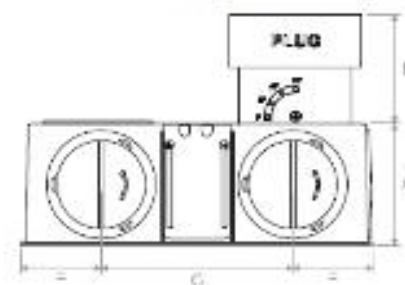

	A	B	C	D	E	F	G	H	I	L
mm	90	256	50	267	80,5	60	140	106	150	90

GRIGLIE GRIDS

GROPPALLI
VMC
DISTRIBUZIONE



GRIBOX-BELLINI



GRIBOX-TIZIANO / GRIBOXPLA - TIZIANO



GRIBOX-GRECO



GRIBOX-GIOTTO / GRIBOXPLA-GIOTTO



GRIBOXPLA-MONET



GRIBOXPLA-KLIMT



GRIBOXPLANA



GRIBOX03-GIOTTO

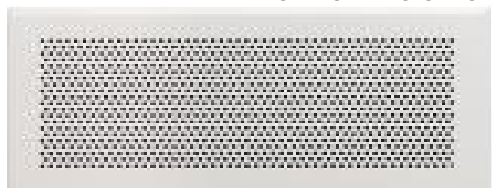

Griglie per VMC realizzate in acciaio con verniciatura o in ABS (anti UV), RAL 9003 lucido (altri RAL a richiesta). Fissaggio con clips (kit clips fornito in ogni griglia).

CMV grilles made of painted steel or ABS (anti UV), with RAL 9003 polish paint (other RAL on request). Fastening made with clips (they are supplied with each grille).

GRIGLIE IN ACCIAIO VERNICIATO - PAINTED STEEL GRILLES

Codice - Code	Prezzo - Price
GRIBOX-BELLINI	81,13 €
GRIBOX-TIZIANO	74,17 €
GRIBOX-GRECO	76,48 €
GRIBOX-GIOTTO	74,03 €
GRIBOX03-GIOTTO *	68,39 €

* Solo per BOXPRE03-BB

GRIGLIE IN ABS - ABS GRILLES

Codice - Code	Prezzo - Price
GRIBOXPLA-MONET	28,35 €
GRIBOXPLA-TIZIANO	28,35 €
GRIBOXPLA-KLIMT	28,35 €
GRIBOXPLA-GIOTTO	28,35 €
GRIBOXPLANA	28,35 €

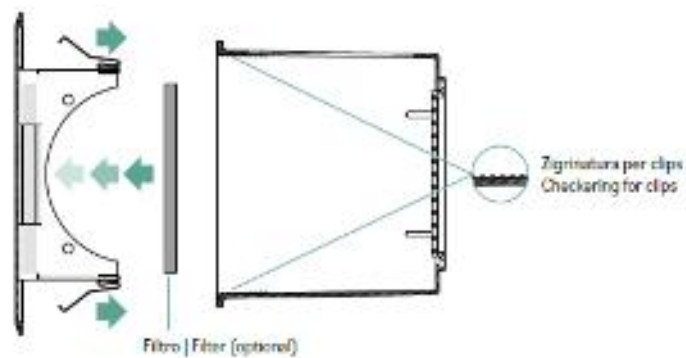

	A	B	C	D	E	H
mm	39	241	280	130	3	91



PLENUM E DISTRIBUZIONE

DISTRIBUTION PLENUM

Plenum di distribuzione multidirezionale realizzato in lamiera zincata con **isolamento fonoassorbente interno**.
Multidirectional distribution plenum made of galvanized sheet with **internal acoustic insulation**.

04-PLE01-BB

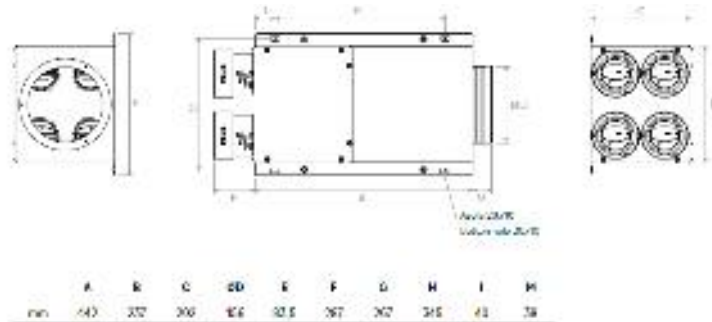

Prezzo - Price
178,50 €

06-PLE01-BB

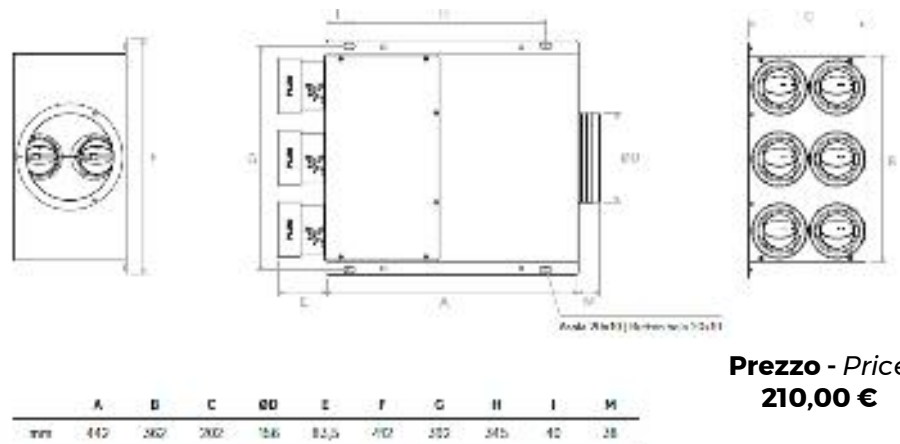

Prezzo - Price
210,00 €

10-PLE01-BB

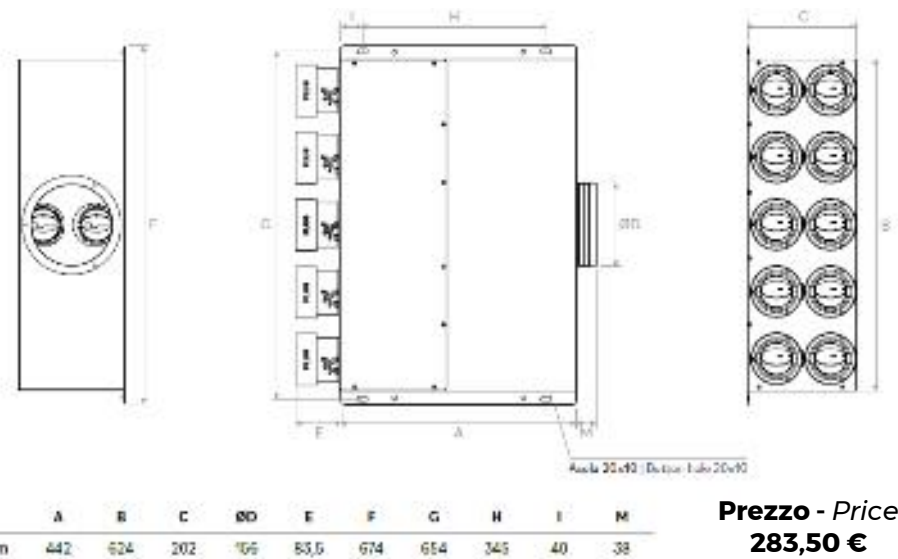

Prezzo - Price
283,50 €

12-PLE01-BB *

* Su richiesta anche il plenum da 12 uscite. Chiedere disponibilità
Plenum with 12 outputs on request. Ask for availability

Prezzo - Price
403,20 €

CONDOTTI FLESSIBILI

FLEXIBLE PIPES

GROPPALLI
VMC
DISTRIBUZIONE



Tubo flessibile in PE doppia parete, interno liscio con trattamento ANTIBATTERICO Ø75 Rotolo 50 metri - Colore bianco

Double wall PE flexible pipe, inner smooth wall with ANTI-BACTERIAL treatment Ø75 - 50 meters - White color

Codice - Code

75-50VENTOFLEX5

Prezzo - Price

189,75 €



Tubo flessibile in PE doppia parete, interno liscio con trattamento ANTIBATTERICO Ø75 Rotolo 50 metri - Colore verde

Double wall PE flexible pipe, inner smooth wall with ANTI-BACTERIAL treatment Ø75 - 50 meters - Green color

Codice - Code

75-50VENTOFLEX5GREEN

Prezzo - Price

189,75 €



Tubo flessibile in PE doppia parete, interno liscio con trattamento ANTIBATTERICO Ø90 Rotolo 50 metri - Colore bianco

Double wall PE flexible pipe, inner smooth wall with ANTI-BACTERIAL treatment Ø90 - 50 meters - White color

Codice - Code

90-50VENTOFLEX5

Prezzo - Price

255,75 €



Manicotto di giunzione per tubi flessibili in PP

Colore bianco - Guarnizioni NON incluse

PP sleeve to joint flexible pipes

White color - Seals NOT included

In confezione da 5 pz - In 5 pieces box

Codice - Code

75-MANICOTTO5-KIT5

Ø75

Prezzo confezione - Box price

Prezzo - Price

14,82 €

90-MANICOTTO5-KIT5

Ø90

Prezzo confezione - Box price

15,41 €



Guarnizioni in gomma - Colore nero

Rubber seals for flexible pipe - Black color

Confezione da 10 pz - In 10 pieces pack

Codice - Code

75-GUARNIZIONE5-KIT10

Ø75

Prezzo confezione - Box price

Prezzo - Price

18,90 €

90-GUARNIZIONE5-KIT10

Ø90

Prezzo confezione - Box Price

22,05 €



CONDOTTI ISOLATI INSULATED PIPES

**Tubo flessibile in alluminio Ø160 mm, fonoassorbente, isolamento in fibre di poliestere
spessore 25mm (confezione da 10m)**

*Aluminium aponic flexible pipe Ø160 mm insulated by a layer of polyester
Tickness 25mm (pack of 10m)*

Codice - Code	Rotoli da 10 m – 10 m roll	Prezzo - Price
160-10FLEXISOALU-BB		144,00 €



**Tubo flessibile in PVC Ø160mm isolato con materassino di poliestere di spessore 25mm
(confezione da 10 m)**

*PVC flexible pipe Ø160mm insulated by a layer of polyester
Tickness 25mm (pack of 10 m)*

Codice - Code	Rotoli da 10 m – 10 m roll	Prezzo - Price
160-10FLEXISOPVC-BB		120,00 €



Tubo isolante spiralato in POLIETILENE
*Spiral pipe insulated by a layer of polyester
Polyethylene material*

Codice - Code		Pezzi conf. Box pieces	Prezzo un. Unit price
125-2000SPIR5	Prolunga L=2000 Ø125 – Extension L=2000 Ø125	8	62,37 €
160-2000SPIR5	Prolunga L=2000 Ø160 – Extension L=2000 Ø160	6	72,63 €
180-2000SPIR5	Prolunga L=2000 Ø180 – Extension L=2000 Ø180	4	99,23 €
200-2000SPIR5	Prolunga L=2000 Ø200 – Extension L=2000 Ø200	4	140,71 €



Codice - Code		Pezzi conf. Box pieces	Prezzo un. Unit price
125-90SPIR5	Curva 90° Ø125 – 90° Ø125 elbow	1	34,59 €
160-90SPIR5	Curva 90° Ø160 – 90° Ø160 elbow	1	41,08 €
180-90SPIR5	Curva 90° Ø180 – 90° Ø180 elbow	1	51,54 €
200-90SPIR5	Curva 90° Ø200 – 90° Ø200 elbow	1	56,32 €



Codice - Code		Pezzi conf. Box pieces	Prezzo un. Unit price
125-45SPIR5	Curva 45° Ø125 – 45° Ø125 elbow	1	23,55 €
160-45SPIR5	Curva 45° Ø160 – 45° Ø160 elbow	1	31,92 €
180-45SPIR5	Curva 45° Ø180 – 45° Ø180 elbow	1	39,40 €
200-45SPIR5	Curva 45° Ø200 – 45° Ø200 elbow	1	45,00 €



Codice - Code		Pezzi conf. Box pieces	Prezzo un. Unit price
125FASCIA5 *	Fascetta di giunzione Ø125 per tubo in polietilene - Ø125 connection clamp for polyethylene pipe	1	7,05 €
160FASCIA5 *	Fascetta di giunzione Ø160 per tubo in polietilene - Ø160 connection clamp for polyethylene pipe	1	8,23 €
180FASCIA5 *	Fascetta di giunzione Ø180 per tubo in polietilene - Ø180 connection clamp for polyethylene pipe	1	9,40 €



***Chiedere disponibilità**
**Ask for availability*

ACCESSORI PER LA VMC CMV ACCESSORIES

Griglie da esterno antintrusione in alluminio per tubo spiralato External aluminium grid for insulated pipes

Codice - Code		Prezzo - Price
125DFHALUVENT	Ø125	10,56 €
160DFHALUVENT	Ø160	12,48 €
180DFHALUVENT	Ø180	14,08 €



Griglia di immissione aria in plastica Ø125 Plastic air intake grill Ø125

VSP125	Ø125	25,85 €
--------	------	---------



Griglia di evacuazione ed aspirazione aria in plastica Ø125 Plastic evacuation and air intake grill Ø125

VSE125	Ø125	25,85 €
--------	------	---------



Camino per aspirazione aria Ø 160 per tubo isolato in PP nero anti uv External vertical terminal Ø160 for insulated pipes in black PP anti uv

160ST58*	Ø160	81,53 €
----------	------	---------

*Chiedere disponibilità - Ask for availability



Tegola per camino Ø 160 in alluminio verniciato nero per tetti piatti e inclinati External adjustable roof for vertical terminal Ø160 black painted

160TEJA	Ø160	66,15 €
---------	------	---------

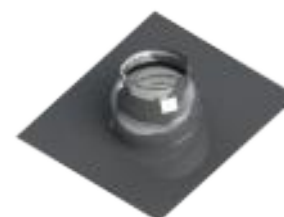

Adattatori in PP Maschio-Maschio Male-Male PP adapters

125160AMPMM5	da Ø125 M a Ø160 M	25,20 €
160180AMPMM5	da Ø160 M a Ø180 M	26,25 €
160200AMPMM5	da Ø160 M a Ø200 M	42,00 €



Filtri di ricambio per unità di ventilazione - efficienza G4 Replacement filter, efficiency G4, for ventilation unit

UNIFILTRO-BB	2 pezzi - 2 pieces	64,37 €
UNIFILTROF7-BB	2 pezzi - 2 pieces	70,00 €



Silenziatore flessibile Ø 160mm Flexible sound attenuator Ø 160mm

160-500SILENT	1 pezzo - 1 piece	L=500	99,75 €
160-1000SILENT	1 pezzo - 1 piece	L=1000	164,85 €





ACCESSORI PER LA VMC CMV ACCESSORIES

Codice - Code

Prezzo - Price



Curve per tubo flessibile Ø75/90 uscita Ø125 da soffitto/controsoffitto
Bends for Ø75/90 flexible duct with Ø125 ceiling/false ceiling outlet

SCY1X7590	Curva singola utenza per flessibile Ø75 o Ø90 uscita Ø125	12,20 €
SCY2X7590	Curva doppia utenza per flessibile Ø75 o Ø90 uscita Ø125	19,80 €



Curve per tubo flessibile Ø75/90 uscita Ø125 da soffitto/controsoffitto con prolunga
Bends for Ø75/90 flexible duct with Ø125 ceiling/false ceiling outlet with extension

STL1X7590	Curva singola utenza per flessibile Ø75 o Ø90 uscita con prolunga L500 Ø125	22,60 €
STL2X7590	Curva doppia utenza per flessibile Ø75 o Ø90 uscita con prolunga L500 Ø125	28,90 €



Plenum 6 uscite Ø75 ingresso Ø125 in EPS grafitato
6-port distribution plenum, Ø75 outlets, Ø125 inlet, in graphite EPS

06X75-PLEFIG-EPS	Plenum in EPS antibatterico grafitato Ø75, 6 uscite, ingresso Ø125	133,00 €
------------------	--	----------



Plenum in FOAM per tubo flessibile Ø75 e Ø90 a basso ingombro
Low-profile FOAM plenum box for Ø75 and Ø90 flexible ducts

CD4X7590-100PFTAP	Plenum distribuzione basso ingombro 4 uscite Ø75/90 ingresso Ø100 con isp.	90,50 €
CD6X7590-125PFTAP	Plenum distribuzione basso ingombro 6 uscite Ø75/90 ingresso Ø125 con isp.	108,00 €
CD8X7590-125PFTAP	Plenum distribuzione basso ingombro 8 uscite Ø75/90 ingresso Ø125 con isp.	150,00 €



Plenum in FOAM per tubo flessibile Ø75 e Ø90
FOAM plenum box for Ø75 and Ø90 flexible ducts

04X7590-PLEFIG-FOAM	Plenum distribuzione 4 uscite Ø75/90 ingresso Ø160 con ispezione	98,00 €
06X7590-PLEFIG-FOAM	Plenum distribuzione 6 uscite Ø75/90 ingresso Ø160 con ispezione	135,00 €
08X7590-PLEFIG-FOAM	Plenum distribuzione 8 uscite Ø75/90 ingresso Ø160 con ispezione	150,00 €
10X7590-PLEFIG-FOAM	Plenum distribuzione 10 uscite Ø75/90 ingresso Ø160 con ispezione	190,00 €

NEW

Nuova bocchetta GROPPALLI



KIT COMPLETO:

1. **plenum in ABC**
2. **4 tappi** di chiusura;
3. **2 staffe** di fissaggio regolabile;
4. coperchio di protezione;
5. **portafiltro** d'aria;
6. griglia in acciaio
7. **adattatore a forcella** *
8. **adattatore a forcella DN 75** *
9. **adattatore a forcella DN 90**

CARATTERISTICHE TECNICHE:

Telaio: **ABC**
Manicotti: **PP**
Griglia: **Acciaio**
Staffe: **Lamiera Zincata**

Connessioni:
DN 75, DN 90 a fissaggio rapido



SISTEMI DI TUBAZIONI CORRUGATE

CSST FOR SOLAR, WATER AND GAS TUBE
FITTINGS FOR CSST SOLAR, WATER AND GAS TUBE
TOOLS FOR CSST TUBE

TUBI RIVESTITI CORRUGATI FORMABILI CSST PER
SOLARE TERMICO, ACQUA E GAS RACCORDERIA PER
TUBAZIONI CSST DI GAS, ACQUA E SOLARE TERMICO
ACCESSORI PER TUBO CSST

TUBO CSST CSST TUBE



DESCRIZIONE DESCRIPTION	CODICE ARTICOLO ARTICLE CODE	FILETTO CONN. CONN. THREAD	Ø EST.	Ø INT.	METRI METRES	PREZZO PRICE (€)	
<p>Tubo CSST corrugato binato in AISI 316L austenitico conforme ai requisiti del DM 174/2004 per acqua potabile con rivestimento in EPDM espanso da 13 mm cavo sonda per impianti solari termici.</p> <p><i>Double pliable corrugated CSST tubing in 1.4404 (AISI 316L) austenitic stainless steel (suitable for drinking water) with coating in expanded EPDM 13 mm thick for thermal solar plants and sensor cable</i></p>	34-25SOLARFLEX	3/4"	21,3	16,2	25		 <p>Chiedere per prezzo Ask for prices</p>
	34-50SOLARFLEX	3/4"	21,3	16,2	50		
	34-100SOLARFLEX	3/4"	21,3	16,2	100		
	1-25SOLARFLEX	1"	26,4	20,9	25		
	1-50SOLARFLEX	1"	26,4	20,9	50		
	1-100SOLARFLEX	1"	26,4	20,9	100		
<p>Tubo corrugato CSST in 1.4301 (AISI 304) austenitico certificati da BV secondo la UNI EN15266 per allacciamenti termo-idro-sanitari conforme ai requisiti del DM 174/2004</p> <p>Compatibile con EU e MA Compatibile con EM</p> <p><i>Pliable corrugated CSST tubes, conform to EN ISO 10380 in 1.4301 (AISI304) austenitic stainless steel, for connections and thermo-hydro-sanitary plants (suitable for drinking water)</i></p>	12-5ACQUAFLEX	1/2"X	16,8	13,2	5	38,20	
	12-25ACQUAFLEX	1/2"X	16,8	13,2	25	191,20	
	12-5ACQUAFLEX-B	1/2"	15,8	12	5	38,20	
	12-25ACQUAFLEX-B	1/2"	15,8	12	25	191,20	
	34-5ACQUAFLEX	3/4"	20	15,8	5	46,40	
	34-25ACQUAFLEX	3/4"	20	15,8	25	232,00	
	1-5ACQUAFLEX	1"	25	19,7	5	69,92	
	1-25ACQUAFLEX	1"	25	19,7	25	349,40	
<p>Tubo corrugato CSST in 1.4404-AISI 316L austenitico certificati da BV secondo la UNI EN15266 con rivestimento protettivo di colore giallo per allacciamenti e impianti GAS. MOP = 0,5 bar</p> <p><i>Pliable corrugated CSST tubes, conform to EN 15266 and DVGW G5616, in 1.4404 AISI 316L austenitic stainless steel with yellow external protecting coating, for GAS connections and plants. Maximum operative pressure: MOP = 0,5 bar</i></p>	12-5GASFLEX	1/2"	15,8	12	5	69,12	
	12-10GASFLEX	1/2"	15,8	12	10	138,24	
	34-5GASFLEX	3/4"	20	15,8	5	90,00	
	34-10GASFLEX	3/4"	20	15,8	10	180,00	
	1-5GASFLEX	1"	25	19,7	5	113,24	
	1-10GASFLEX	1"	25	19,7	10	226,48	
	114-5GASFLEX	1"1/4	33	26,5	5	163,44	
	114-10GASFLEX	1"1/4	33	26,5	10	326,88	
<p>Tubo corrugato CSST in 1.4404-AISI 316L austenitico a norma UNI EN 15266 e con rivestimento protettivo di colore giallo e dadi girevoli pre-assemblati alle estremità per il collegamento secondo le norme UNI 7129/UNI7131 di apparecchiature gas fisse o ad incasso MOP = 0,5 bar</p> <p><i>Pliable corrugated CSST tubing conform to EN 15266 in 1.4404 (AISI 316L) austenitic stainless steel with yellow external protecting coating and pre-assembled swivel nuts for the connections of stationary gas appliances. MOP = 0,5 bar</i></p>	12-3PREGASFLEX	1/2"	15,8	12	3	38,00	
	12-4PREGASFLEX	1/2"	15,8	12	4	45,80	

RACCORDERIA PER TUBO CSST
FITTINGS FOR CSST TUBE

SOLARE

DESCRIZIONE DESCRIPTION	CODICE ARTICOLO ARTICLE CODE	FILETTO CONN. CONN.THREAD	PEZZI PIECES	PREZZO PRICE (€)	
RACCORDI DI GIUNZIONE MASCHIO Raccordi in ottone a tenuta metallo su metallo con filettatura maschio ISO 228G per tubi CSST per impianti solari termici MALE JUNCTION FITTINGS Metal to metal seal brass fittings With ISO 228 G male thread for CSST tubing for thermal solar plants	34MARACSOLARFLEX	3/4"	1	15,20	
	1MARACSOLARFLEX	1"	1	18,84	
RACCORDI DI GIUNZIONE FEMMINA Raccordi in ottone a tenuta metallo su metallo con filettatura femmaschio ISO 228G per tubi CSST per impianti solari termici FEMALE JUCTION FITTINGS Metal to metal seal brass fittings with ISO 228 G female thread for CSST tubing for thermal solar plants	34FERACSOLARFLEX	3/4"	1	15,32	
	1FERACSOLARFLEX	1"	1	18,92	



ACQUA E GAS

DESCRIZIONE DESCRIPTION	CODICE ARTICOLO ARTICLE CODE	FILETTO CONN. CONN.THREAD	PEZZI PIECES	PREZZO PRICE (€)	
DADO IN OTTONE NICHELATO con filettatura femmina ISO 228G con guarnizioni piane in fibra sintetica per acqua NUTS + GASKETS Nickel plated brass nut female thread with syntetic fiber gaskets for water	12DADOACQUAFLEX <i>Compatibile con: EU e MA</i>	1/2"X	10	1,32	
DADO IN OTTONE NICHELATO con filettatura femmina ISO 228G e con guarnizioni piane in fibra sintetica per acqua e gas NUTS + GASKETS Nickel plated brass nut female for water and gas <i>Compatibile con: EM, EU gas</i>	12DADOACQUAGASFLEX-B	1/2"	10	1,44	
DADO IN OTTONE NICHELATO con filettatura femmina ISO 228G e guarnizioni piane in fibra sintetica per acqua e gas NUTS + GASKETS Nickel plated brass nut female for water and gas	34DADOACQUAGASFLEX	3/4"	10	2,20	
DADO IN OTTONE NICHELATO con filettatura femmina ISO 228G e guarnizioni piane in fibra sintetica per acqua e gas NUTS + GASKETS Nickel plated brass nut female for water and gas	1DADOACQUAGASFLEX	1"	10	3,84	
DADO IN OTTONE NICHELATO con filettatura femmina ISO 228G e guarnizioni piane in fibra sintetica per acqua e gas NUTS + GASKETS Nickel plated brass nut female for water and gas	114DADOACQUAGASFLEX	1"1/4	10	8,08	
NIPPLI PARALLELLI - M/M Maschio/Maschio parallelo in ottone nichelato con doppia filettatura ISO 228 G e battute piane maggiorate per acqua e gas PARALLEL M/M NIPPLES Nickel plated brass male/male nipples with double ISO 228 G male threadsabd and increased flat surface for water and gas	12NIPACQUAGASFLEX	1/2"	10	3,80	
	34NIPACQUAGASFLEX	3/4"	10	5,96	
	1NIPACQUAGASFLEX	1"	5	6,16	
	144NIPACQUAGASFLEX	1"1/4	5	10,76	

SET DI FLANGIATURA PER TUBI CSST
FLANGING SET FOR CSST TUBES

DESCRIZIONE DESCRIPTION	CODICE ARTICOLO ARTICLE CODE	QUANT. PCS.	PREZZO PRICE (€)	
KIT FLANGIATURA (compatibile EU e MA)	KITFLANGIAFLEX	1	364,00	
CONTENUTO: <ul style="list-style-type: none"> - Valigetta nera - 1 cf 12DADOACQUAFLEX - 1 cf 12DADOACQUAGASFLEX-B - 2 cf 34DADOACQUAGASFLEX - Cartellatrice - Tagliatubi - Dima per 1/2" e 3/4" - Dima per 1/2"X e 3/4" 			Dimensioni valigetta <i>Carrying case dimensions</i> 260 x 210 x 76 mm	
KIT FLANGIATURA (compatibile EMI)	KITFLANGIAFLEX-B	1	320,00	
CONTENUTO: <ul style="list-style-type: none"> - Valigetta nera - 2 cf 12DADOACQUAGASFLEX-B - 2 cf 34DADOACQUAGASFLEX - Cartellatrice - Tagliatubi - Dima per 1/2" e 3/4" 			Dimensioni valigetta <i>Carrying case dimensions</i> 260 x 210 x 76 mm	

ACCESSORI
TOOLS

DESCRIZIONE DESCRIPTION	CODICE ARTICOLO ARTICLE CODE	QUANT. PCS.	PREZZO PRICE (€)	
DIMA PER TUBI CSST PER ACQUA	DIMACQUAFLEX	1	28,80	
DIMA PER TUBI CSST PER GAS	DIMAGASFLEX	1	28,80	
CARTELLATRICE MANUALE UNIVERSALE	CARTELLAFLEX	1	100,60	
TAGLIATUBI PER TUBI CSST DA Ø10 A Ø25	TAGLIAINOXFLEX	1	54,08	

Dimensioni tubo CSST - CSST tube dimensions

GAS - ACQUA

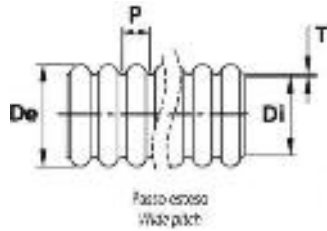

SOLARE

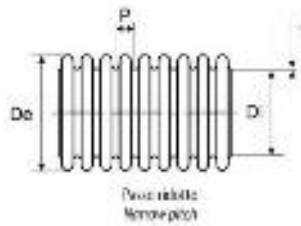

ACQUA

Dimensione nominale Nominal dimension	DN 10	DN 12	DN 12X	DN 15	DN 20	DN 25
Filetto di connessione Connection thread	3/8"	1/2"	1/2"	3/4"	1"	1 1/4"
Spessore T Thickness T	0,25	0,3	0,3	0,3	0,3	0,3
Diametro interno Di Internal diameter Di	9,3	12,0	13,2	15,8	19,7	26,5
Diametro esterno De External diameter De	12,2	15,8	16,8	20,0	25,0	33,0
Passo P Pitch P	4,0	5,0	5,1	5,5	6,4	7,1

GAS

Dimensione nominale Nominal dimension		DN 12		DN 15	DN 20	DN 25
Filetto di connessione Connection thread		1/2"		3/4"	1"	1 1/4"
Spessore T Thickness T		0,3		0,3	0,3	0,3
Diametro interno Di Internal diameter Di		12,0		15,8	19,7	26,5
Diametro esterno De External diameter De		15,8		20,0	25,0	33,0
Passo P Pitch P		5,0		5,5	6,4	7,1

SOLARE

Dimensione nominale Nominal dimension				DN 15	DN 20	DN 25
Filetto di connessione Connection thread				3/4"	1"	1 1/4"
Spessore T Thickness T				0,18	0,18	0,2
Diametro interno Di Internal diameter Di				16,2	20,9	25,0
Diametro esterno De External diameter De				21,3	26,4	31,2
Passo P Pitch P				4,9	5,2	5,6

Raggio curvatura CSST solare Solar tube CSST radius of curvature

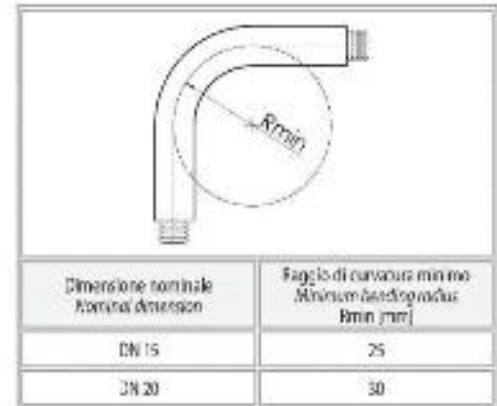

Raggio curvatura CSST acqua e gas Water and gas CSST tube radius of curvature

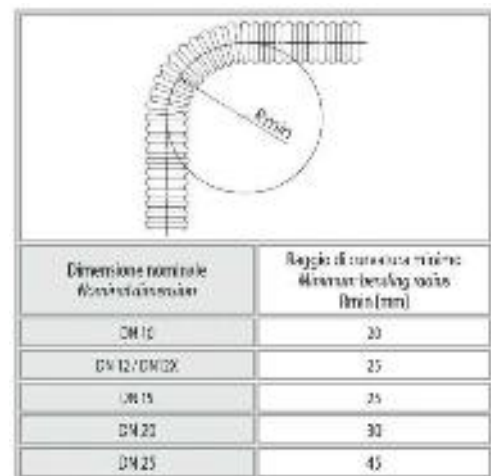



ACCESSORI PER IL TERMODINAMICO

ACCESSORIES FOR THERMODYNAMIC SYSTEMS

GLICOLE

Glicole

DESCRIZIONE DESCRIPTION	SPECIFICHE SPECIFICATIONS	CODICE ARTICOLO ARTICLE CODE	PREZZO PRICE (€)	
Glicole atossico	Glicole antigelo, refrigerante, biodegradabile, atossico e anticorrosione Tanica da 5 Kg	GLICOLTEK-5	52,08	
	<i>Glycol antifreeze, coolant, biodegradable, non-toxic and anti-corrosion 5 Kg tank</i>			
Minimo d'ordine: 4 taniche o multipli <i>Minimum order: 4 cans or multiples</i>				
<i>Non-toxic glycol</i>				



CONDIZIONI GENERALI DI VENDITA GENERAL TERMS OF SALE

La Gropalli S.r.l. non risponde di alcun danno conseguente ad una installazione o ad un utilizzo del prodotto non conformi alle regole dell'arte o alle indicazioni fornite dal produttore.

Lo stesso vale per conseguenze dannose dovute a omesse manutenzioni periodiche da parte dei soggetti a ciò tenuti, dovuta a errata valutazione delle caratteristiche del prodotto da parte del cliente, o all'impiego – anche parziale – di componenti o accessori non forniti dal Fabbricante stesso.

La Gropalli S.r.l. inoltre non risponde di alcun danno o controversia arrecati dal prodotto nel caso quest'ultimo venga alterato in qualsiasi suo aspetto o forma, rispetto alle specifiche tecniche concordate con il Cliente.

Ogni prodotto Gropalli, se non diversamente ed espressamente specificato, è idoneo esclusivamente ad installazioni Interne.

I prodotti di cui alla presente offerta sono conformi alla normativa dell'Unione Europea, in particolare al Regolamento n.305/2011.

Per prodotti mancanti o danneggiati sono presi in considerazione soltanto i reclami ricevuti entro otto giorni dalla data di consegna.

Tutti i termini di consegna concordati devono intendersi con una tolleranza di sette giorni lavorativi.

L'ordine senza specifiche riserve implica la formazione dell'accordo su tali condizioni, nonché approvazione dei disegni tecnici allegati all'offerta.

Pagamenti per ordini inferiori a 1.000€ in un'unica soluzione.

Non si accettano resi che non siano preventivamente concordati, il reso deve tenere traccia scritta in merito alla procedura da attuare.

La garanzia legale del prodotto è pari a 2 (due) anni a decorrere dalla data di spedizione dei magazzini della Gropalli S.r.l.

Non si accettano resi in caso di errata ordinazione.

La sostituzione di eventuali prodotti risultati difettosi in fase di installazione può essere richiesta compilando il relativo modulo; comunque solo se la matricola presente sul prodotto rientra nel periodo di garanzia legale sopra indicato.

Tutti gli ordini dovranno essere inviati a: **gd-ordini@gropalli.it**

Ogni controversia su prodotti Gropalli S.r.l. è regolata dalla legge italiana e il Foro competente è il Foro di Milano.

Gropalli S.r.l. denies any liability related to wrong installations and/or any use of the product not in compliance with the general normative rules or the manufacturer's instructions.

The same applies to any damage caused by the omission of the periodic maintenance performed by authorized Personnel or by the customer's wrong assessment of the product features or by the use, even partial one, of the components or accessories not provided by the manufacturer itself. Furthermore, Gropalli S.r.l. is not liable for any damages caused by the products or for any disputes arising from any alterations in their appearance or shape in relation to the technical specifications agreed with the Customer.

Each Gropalli product, if not otherwise specified, is suitable for indoor installations only.

The products listed in the present offer are in compliance with the European Union normative, with the Regulation n. 305/2011 in particular.

Claims for missing or damaged goods will be taken into account only if submitted within 7 days after the delivery date.

All agreed lead times are meant having a seven working days tolerance.

The purchase order without any special conditions implies the acceptance of the stated terms as well as the approval of the attached technical drawings.

We don't accept returned goods if not previously agreed.

All purchase orders must be sent to: **gd-ordini@gropalli.it**

Every controversy arising around any Gropalli S.r.l. product is subject to the Italian legislation and the competent jurisdiction is the Court of Milan.

GROPPALLI

Groppalli S.r.l. - Distribuzione -

Loc. Pilastro di Gragnano S.N.C.

29010 Gragnano Trebbiense
Piacenza - Italy

TEL: +39 0523 78 88 12

MAIL: gd-ordini@groppalli.it

SITO: www.groppalli.it

