

ACCESSORI CONDIZIONAMENTO

ACCESSORIES FOR AIR CONDITIONING SYSTEMS

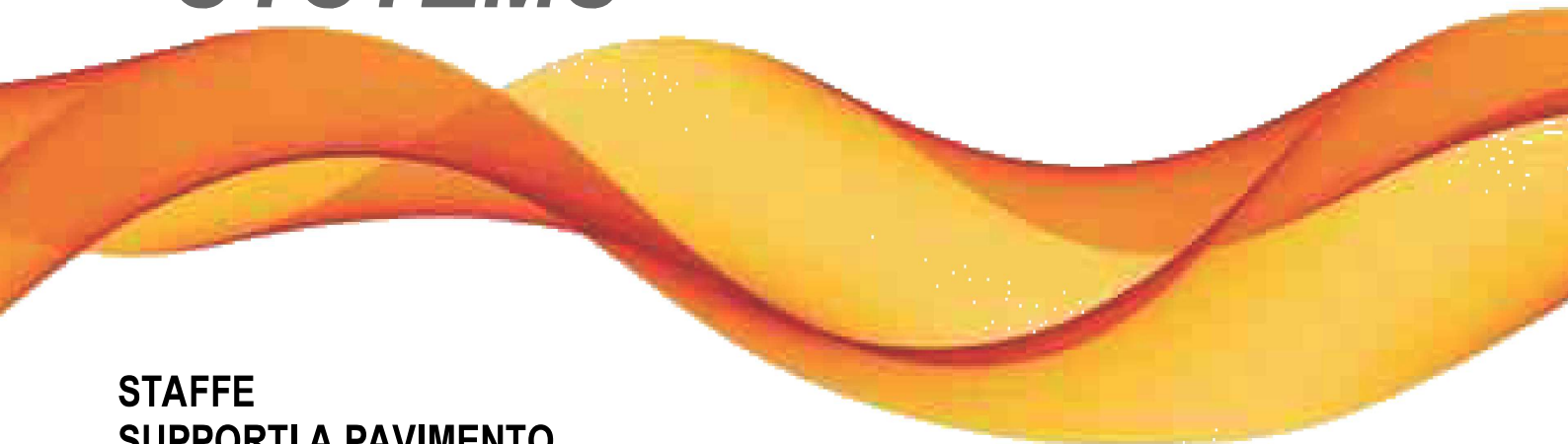

**STAFFE
SUPPORTI A PAVIMENTO
CANALINA
TUBO SCARICO CONDENZA
NASTRI ANTICONDENZA
RACCORDERIA**

*SUPPORT BRACKETS
FLOOR SUPPORTS
DUCTS
CONDENSATE DRAIN PIPE
CONDENSATE TAPES
FITTINGS*

ACCESSORI PER CONDIZIONAMENTO ACCESSORIES FOR AIR CONDITIONING SYSTEMS



GROPPALLI
FLUE SYSTEMS
DISTRIBUZIONE

LINEA STAFFE SUPPORT BRACKETS

DESCRIZIONE DESCRIPTION	SPECIFICHE SPECIFICATION	CODICE ARTICOLO ARTICLE CODE	MISURA SIZE (mm)	Pz/Conf Pcs/Box	PREZZO PRICE (€)	
Mensola in acciaio ricoperta da plastica anticorrosione e ANTI-UV, bulloneria inclusa	Con traversa Portata: 100 kg Pallet completo: 32 pz With crossbar Load capacity: 100 kg Full pallet: 32 pcs	MENSOLTEK	L440 x H405	1	50,22	
Iron bracket covered with anti-corrosion and NO-UV plastic, INOX screws included	Senza traversa Portata: 100 kg Pallet completo: 96 pz No crossbar Load capacity: 100 kg Full pallet: 96 pcs	MENSOLTEK-ST	L440 x H360	1	40,76	
			CHIEDERE DISPONIBILITA'			
Mensola in acciaio con traversa - montaggio rapido	Mensola in acciaio verniciato, con traversa, bulloneria inclusa	Portata Load capacity 80 kg				
Iron bracket with crosspiece fast assembling	Iron painted bracket with crosspiece, screws included	Bancale completo Full pallet 105 pcs	MENCT-80	L450 x H380	1	
Mensola in acciaio premontata con traversa	Acciaio elettrozincato Bulloneria inclusa	Portata Load capacity 150 kg				
Preassembled iron bracket with crosspiece	Electro-galvanized iron Screws included	Bancale completo Full pallet 100 pcs	MENCT-150	L420 x H500	1	
			CHIEDERE DISPONIBILITA'			
Mensola in acciaio premontata con traversa	Acciaio elettrozincato Bulloneria inclusa					
Preassembled iron bracket with crosspiece	Electro-galvanized iron Screws included		MENCT-150L60	L600 x H500	1	
			L600 x H500			
Mensola in acciaio premontata con traversa	Acciaio elettrozincato Bulloneria inclusa	Portata Load capacity 160 kg				
Preassembled iron bracket with crosspiece	Electro galvanized iron Screws included	Bancale completo Full pallet 120 pcs	MENCT-160	L550 x H400	1	

ACCESSORI CONDIZIONAMENTO

ACCESSORIES FOR
CONDITIONING
SYSTEMS

NEW

**ACCESSORI
CONDIZIONAMENTO**

**ACCESSORIES FOR
CONDITIONING
SYSTEMS**

SUPPORTI A PAVIMENTO
FLOOR SUPPORTS

DESCRIZIONE DESCRIPTION	SPECIFICHE SPECIFICATION	CODICE ARTICOLO ARTICLE CODE	MISURA SIZE (mm)	Pz/Conf Pcs/Box	PREZZO PRICE (€)	
Supporti a pavimento trapezoidali per condizionatori <i>Trapezoidal floor supports for air conditioning system</i>	In PVC bianco Dimensioni : 80x80 Confezionati in coppia	SUPAV80-350	80 x 80 L=350	24	4,93 Prezzo cad Single price	
		SUPAV80-450	80 x 80 L=450	24	5,71 Prezzo cad Single price	
	White PVC Dimensions : 80x80 Pair packed	SUPAV80-1000	80 x 80 L=1000	4	13,02 Prezzo cad Single price	
		SUPAV80-CAP	TAPPI 80X80	24	1,26 Prezzo cad Single price	
Supporti a pavimento trapezoidali per condizionatori <i>Trapezoidal floor supports for air conditioning system</i>	In PVC bianco Dimensioni : 100x100 Confezionati in coppia	SUPAV100-350	100 x 100 L=350	24	6,62 Prezzo cad Single price	
		SUPAV100-450	100 x 100 L=450	24	7,67 Prezzo cad Single price	
	White PVC Dimensions : 100x100 Pair packed	SUPAV100-1000	100 x 100 L=1000	4	14,91 Prezzo cad Single price	
		SUPAV100-CAP	TAPPI 100 x 100	24	1,54 Prezzo cad Single price	
Supporti a pavimento conici per condizionatori <i>Conical floor supports for air conditioning system</i>	In PVC rigido <i>Rigid PVC</i>	SUPPORTI-COND01-PERLA PESO MAX. 500 KG	Ø55 - H95	4	16,63 Prezzo kit 4 pz 4 pcs kit price	
Supporti a pavimento conici per condizionatori <i>Conical floor supports for air conditioning system</i>	In Nylon nero <i>Black Nylon</i>	SUPPORTI-COND01	Ø80 - H90	4	16,63 Prezzo kit 4 pz 4 pcs kit price	
Supporti a pavimento conici per Condizionatori Regolabili <i>Conical floor Adjustable supports</i>	In Nylon nero <i>Black Nylon</i>	SUPPORTI-COND02-N	Ø80 - H90	4	21,90 Prezzo kit 4 pz 4 pcs kit price	
	In Nylon bianco <i>White Nylon</i>	SUPPORTI-COND02-B	Ø80 - H90	4	20,96 Prezzo kit 4 pz 4 pcs kit price	
Supporti a pavimento antivibranti <i>No vibrations supports for air conditioning</i>	In Gomma nera <i>Black sbr rubber</i>	BASEPAV-400-AA	L=400	1	53,20 Prezzo kit 2 pz 2 pcs kit price	
	In Gomma nera <i>Black sbr rubber</i>	BASEPAV-600-AA	L=600	1	67,84 Prezzo kit 2 pz 2 pcs kit price	

NEW

ACCESSORI PER CONDIZIONAMENTO ACCESSORIES FOR AIR CONDITIONING SYSTEMS



GROPPALLI
FLUE SYSTEMS
DISTRIBUZIONE

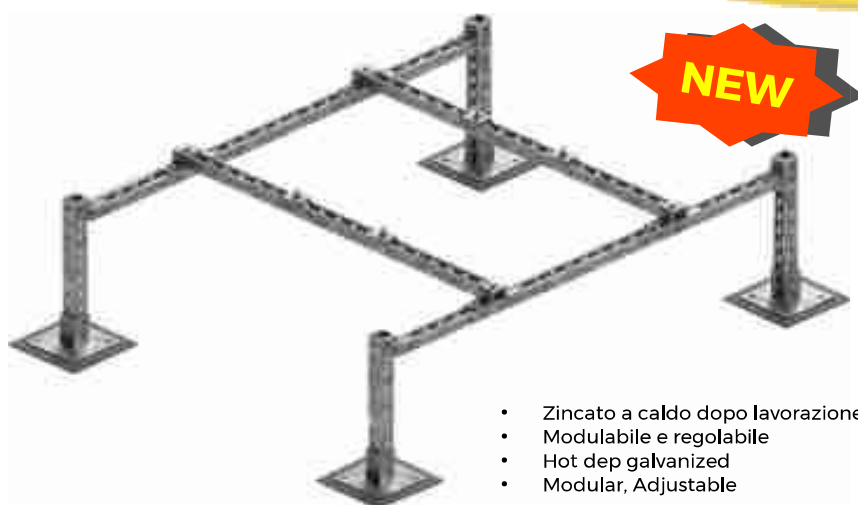

NEW

- Zincato a caldo dopo lavorazione
- Modulabile e regolabile
- Hot dep galvanized
- Modular, Adjustable

DESCRIZIONE DESCRIPTION	CODICE ARTICOLO ARTICLE CODE	MISURA SIZE (mm)	Pz/Conf Pcs/ Box	PREZZO PRICE (€)
Supporto Profilato Modulare per Pompe di calore	SUPROFIL100120	1000 X 1200 H=500	1	370,00
Modular Support Frames for heat pumps or Air Conditioning				

CANALINA ELEGANCE ELEGANCE DUCTS

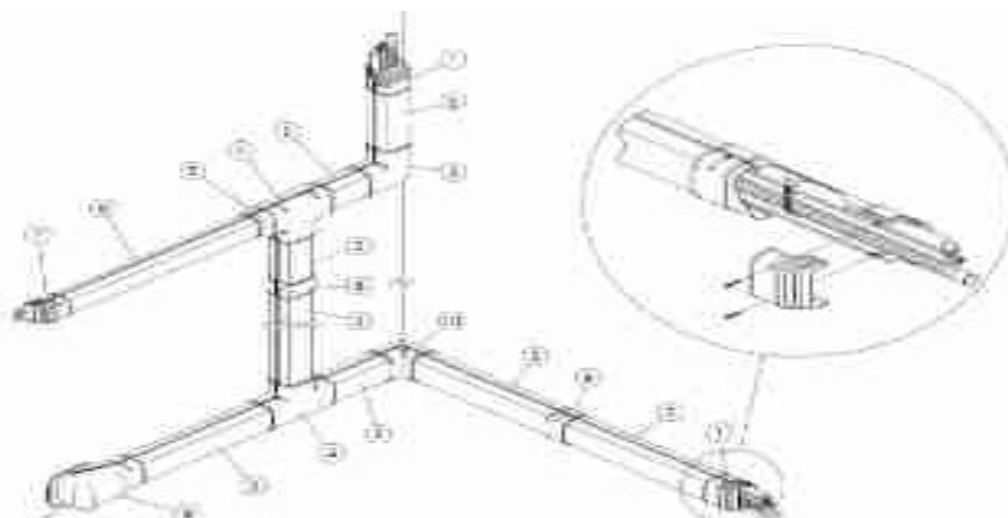

- 1 – TERMINALE
- 2 – CANALINA
- 3 – CURVA PIANA
- 4 – RACCORDO A "T"
- 5 – RIDUZIONE

- 6 – CANALINA
- 7 – TERMINALE
- 8 – GIUNTO DI COLLEGAMENTO
- 9 – TERMINALE DA MURO
- 10 – CURVA AD ANGOLO







ACCESSORI
CONDIZIONAMENTO

ACCESSORIES FOR
CONDITIONING
SYSTEMS

**ACCESSORI
CONDIZIONAMENTO**

**ACCESSORIES FOR
CONDITIONING
SYSTEMS**



CANALINA ELEGANCE
ELEGANCE DUCTS

DESCRIZIONE DESCRIPTION	SPECIFICHE SPECIFI- CATION	CODICE ARTICOLO ARTICLE CODE	MISURA SIZE (mm)	Pz/Conf Pcs/ Box	PREZZO PRICE (€)	
Prolunga 2 mt - canalina Elegance	In polipropilene bianco seta	PROL2000-CANP	60 x 57 L=2000	6	17,32	
		PROL2000-CAN	77 x 67 L=2000	6	19,28	
	2 mt extension - Elegance duct	Silk-white polypropylene	PROL2000-CANG	107 x 77 L=2000	6	
Curva per canalina Elegance	In polipropilene Bianco seta	CURVANGOLO-CANP	60 x 57 - 90°	10	3,06	
		CURVANGOLO-CAN	77 x 67 - 90°	10	3,83	
	Elbow for Elegance duct	Silk-white polypropylene	CURVANGOLO-CANG	107 x 77 - 90°	10	
Curva piatta per canalina Elegance	In polipropilene Bianco seta	CURVAPIANA-CANP	60 x 57 - 90°	10	3,06	
		CURVAPIANA-CAN	77 x 67 - 90°	10	3,87	
	Flat elbow for Elegance duct	Silk-white polypropylene	CURVAPIANA-CANG	107 x 77 - 90°	10	
Giunto per canalina Elegance	In polipropilene Bianco seta	GIUNTO-CANP	60 x 57	10	2,39	
		GIUNTO-CAN	77 x 67	10	2,75	
	Joint for Elegance duct	Silk-white polypropylene	GIUNTO-CANG	107 x 77	10	
Raccordo a TEE per canalina Elegance	In polipropilene Bianco seta	RACCORDO-CAN	77 x 67	10	5,81	
		TEE connection for Elegance duct	Silk-white polypropylene	RACCORDO-CANG	107 x 77	
Terminale per canalina Elegance	In polipropilene Bianco seta	TERMINALE-CANP	60 x 57	10	2,52	
		TERMINALE-CAN	77 x 67	10	3,24	
	Terminal for Elegance duct	Silk-white polypropylene	TERMINALE-CANG	107 x 77	10	
Terminale a muro per canalina Elegance	In polipropilene Bianco seta	TERMURO-CANP	60 x 57	10	4,41	
		TERMURO-CAN	77 x 67	10	5,27	
	Wall terminal for Elegance duct	Silk-white polypropylene	TERMURO-CANG	107 x 77	10	

ACCESSORI PER CONDIZIONAMENTO ACCESSORIES FOR AIR CONDITIONING SYSTEMS







GROPPALLI
FLUE SYSTEMS
DISTRIBUZIONE

DESCRIZIONE DESCRIPTION	SPECIFICHE SPECIFICATION	CODICE ARTICOLO ARTICLE CODE	MISURA SIZE (mm)	Pz/Conf Pcs/ Box	PREZZO PRICE (€)	
Riduzione per canalina Elegance Reduction for Elegance duct	In polipropilene bianco seta Silk-white polypropylene	RID-CAN	77 x 67	10	3,24	
		RID-CANG	107 x 77	10	3,47	
Rosone per canalina Elegance Wallplate for Elegance duct	In polipropilene bianco seta Silk-white polypropylene	ROSONE-CANP	60 x 57	10	7,11	
		ROSONE-CAN	77 x 67	10	7,74	
		ROSONE-CANG	107 x 77	10	7,74	

ATTENZIONE : Gli articoli della linea ELEGANCE non sono compatibili con gli articoli della linea BASIC

WARNING : Items of the ELEGANCE line are not compatible with items of the BASIC line

CANALINA BASIC BASIC DUCTS







DESCRIZIONE DESCRIPTION	SPECIFICHE SPECIFICATION	CODICE ARTICOLO ARTICLE CODE	MISURA SIZE (mm)	Pz/Conf Pcs/Box	PREZZO PRICE (€)	
Prolunga 2 mt - canalina Basic 2 mt Extension - Basic duct	In PVC bianco puro Pure-white PVC	PROFILM2000-P	60 x 45 L=2000	12	8,89	
		PROFILM2000-M	80 x 60 L=2000	8	12,39	
		PROFILM2000-G	110 x 75 L=2000	4	19,22	
Staffe fissaggio cavi per canalina Basic Cable-fixing brackets for Basic duct	In PVC colori vari Various colors PVC	PF.CANBLOCK-P	60 x 45	30	0,35	
		PF.CANBLOCK-M	80 x 60	30	0,39	
		PF.CANBLOCK-G	110 x 75	20	0,46	
Giunto per Canalina Basic Joint for Basic duct	In PVC bianco puro Pure-white PVC	PF.GIUNTO-P	60 x 45	30	1,37	
		PF.GIUNTO-M	80 x 60	30	1,61	
		PF.GIUNTO-G	110 x 75	20	2,03	
Angolo interno per Canalina Basic Internal corner for Basic duct	In PVC bianco puro Pure-white PVC	PF.ANGINT-P	60 x 45	8	2,45	
		PF.ANGINT-M	80 x 60	6	2,80	
		PF.ANGINT-G	110 x 75	4	3,50	

ACCESSORI CONDIZIONAMENTO

ACCESSORIES FOR
CONDITIONING
SYSTEMS

**ACCESSORI
CONDIZIONAMENTO**

**ACCESSORIES FOR
CONDITIONING
SYSTEMS**

DESCRIZIONE DESCRIPTION	SPECIFICHE SPECIFI- CATION	CODICE ARTICOLO ARTICLE CODE	MISURA SIZE (mm)	Pz/Conf Pcs/Box	PREZZO PRICE (€)	
Angolo esterno per canalina Basic	In PVC bianco puro	PF.ANGEST-P	60 x 45	12	2,45	
		PF.ANGEST-M	80 x 60	9	2,80	
	External corner for Basic duct	Pure-white PVC	PF.ANGEST-G	110 x 75	6	
Curva piatta per canalina Basic	In PVC bianco puro	PF.CURVAPIANA-P	60 x 45	10	2,80	
		PF.CURVAPIANA-M	80 x 60	8	3,78	
	Plane elbow for Basic duct	Pure-white PVC	PF.CURVAPIANA-G	110 x 75	6	
Curva a muro per canalina Basic	In PVC bianco puro	PF.CURMURO-P	60 x 45	9	3,19	
		PF.CURMURO-M	80 x 60	6	3,47	
	Corner wall elbow for Basic duct	Pure-white PVC	PF.CURMURO-G	110 x 75	4	
Passaggio a muro per canalina Basic	In PVC bianco puro	PF.WALPAS-P	60 x 45	10	2,38	
		PF.WALPAS-M	80 x 60	16	2,66	
	Wall passage for Basic duct	Pure-white PVC	PF.WALPAS-G	110 x 75	8	
Raccordo a TEE per canalina Basic	In PVC bianco puro	PF.RACT-M	80 x 60	4	5,78	
		PF.RACT-G	110 x 75	4	7,25	
Riduzioni per canalina Basic	In PVC bianco puro	PF.RID-M	Da 80 x 60 a 60 x 45	12	2,07	
		PF.RID-G	Da 110 x 75 a 80 x 60	8	2,35	
Tappo terminale per canalina Basic	In PVC bianco puro	PF.TAPPOTERM-P	60 x 45	12	2,28	
		PF.TAPPOTERM-M	80 x 60	9	2,66	

ATTENZIONE : Gli articoli della linea BASIC non sono compatibili con gli articoli della linea ELEGANCE
WARNING : Items of the BASIC line are not compatible with items of the ELEGANCE line



TUBO SCARICO CONDENSA RIGIDO
RIGID CONDENSATE DRAIN PIPE





DESCRIZIONE DESCRIPTION	SPECIFICHE SPECIFICATION	CODICE ARTICOLO ARTICLE CODE	MISURA SIZE (mm)	Pz/Conf Pcs/Box	PREZZO PRICE (€)	
Tubo scarico condensa rigido <i>Rigid condensate drain pipe</i>	In PVC bianco <i>White PVC</i>	RIGPIPE-20	Ø20 - L =2000	35	3,56	
Clips per tubo scarico condensa Ø20 <i>Clips for condensate drain pipe - Ø20</i>	In PVC bianco <i>White PVC</i>	RIGPIPE-20.CLIP	Ø20	100	0,39	
Manicotto per tubo rigido Ø20 <i>Rigid pipe connector - Ø20</i>	In PVC bianco <i>White PVC</i>	RP-CONNECT	Ø20	20	2,63	
Angolo per tubo rigido 135° - Ø20 <i>Rigid pipe 135° corner - Ø20</i>	In PVC bianco <i>White PVC</i>	RP-CORNER	Ø20	20	2,94	
Curva 90° per tubo rigido - Ø20 <i>Rigid pipe 90° corner - Ø20</i>	In PVC bianco <i>White PVC</i>	RP-90BEND	Ø20	20	2,94	
Raccordo a tee per tubo rigido Ø20 <i>Rigid tee Derivation - Ø20</i>	In PVC bianco <i>White PVC</i>	RP-RACTEE	Ø20	20	3,75	
Riduzione per tubo rigido <i>Reduction for rigid pipe</i>	In PVC bianco <i>White PVC</i>	RIGRED-2520	Da Ø25 a Ø20	20	2,70	
		RIGRED-3225	Da Ø32 a Ø25	20	3,71	

ACCESSORI
CONDIZIONAMENTO
ACCESSORIES FOR
CONDITIONING
SYSTEMS

Accessori
con O-RING

NEW







**Accessori
con GUARNIZIONI**

DESCRIZIONE DESCRIPTION	SPECIFICHE SPECIFI- CATION	CODICE ARTICOLO ARTICLE CODE	MISURA SIZE (mm)	Pz/Conf Pcs/Box	PREZZO PRICE (€)	
Manicotto per tubo rigido Ø20 <i>Rigid pipe connector Ø20</i>	In PVC bianco <i>White PVC</i>	RP-CONNECT-GU	Ø 20	30	1,86	
Angolo per tubo rigido 135° Ø20 <i>Rigid pipe 135° corner Ø20</i>	In PVC bianco <i>White PVC</i>	RP-CORNER-GU	Ø 20	30	1,86	
Curva 90° per tubo rigido Ø20 <i>Rigid pipe 90° corner Ø20</i>	In PVC bianco <i>White PVC</i>	RP-90BEND-GU	Ø 20	30	1,86	
Raccordo a tee per tubo rigido Ø20 <i>Rigid tee derivation for rigid pipe Ø20</i>	In PVC bianco <i>White PVC</i>	RP-RACTEE-GU	Ø 20	30	1,89	
Riduzione per tubo rigido <i>Reduction for rigid pipe</i>	In PVC bianco	RIGRED2520-GU	Da Ø25 a Ø20	30	1,89	
	White PVC	RIGRED3225-GU	Da Ø32 a Ø25	30	2,14	



TUBO SCARICO CONDENZA SPIRALATO
SPIRAL CONDENSATE DRAIN PIPE

ACCESSORI
CONDIZIONAMENTO
ACCESSORIES FOR
CONDITIONING
SYSTEMS



DESCRIZIONE DESCRIPTION	SPECIFICHE SPECIFI- CATION	CODICE ARTICOLO ARTICLE CODE	MISURA SIZE (mm)	Pz/Conf Pcs/ Box	PREZZO PRICE (€)	
*Tubo scarico condensa Spiralato Prodotto Italiano *Spiral condensate drain pipe - Made in Italy	In PVC bianco	SPIRPIPE-16	Ø16 Rotolo da 30 m	1	31,05	
	*sono necessari accessori	SPIRPIPE-18	Ø18 Rotolo da 30 m	1	35,35	
	White PVC	SPIRPIPE-20	Ø20 Rotolo da 30 m	1	37,31	
	*accessories needed	SPIRPIPE-25	Ø25 Rotolo da 30 m	1	44,98	
Raccordo da tubo rigido Ø20 a tubo spiralato Connector from rigid pipe Ø20 to spiral pipe	Gomma	UNIRAC-16 (Giallo)	Ø16	10	3,10	
		UNIRAC-18 (Rosso)	Ø18	10	3,18	
		UNIRAC-20 (Blu)	Ø20	10	3,27	
	Rubber	UNIRAC-25 (Verde)	Ø25	10	3,34	
		UNIRAC-32 (Grigio)	Ø32	10	3,42	
Giunto a Y Asimmetrico per tubo spiralato Ø16 e Ø18 Asymmetrical Y joint for Ø16 And Ø18 spiral pipe	PVC	RACSPIR-Y	Ø16 - Ø18	20	1,33	
	PVC					
Giunto a Y Simmetrico per tubo spiralato Ø16 - Ø18 - Ø20 Symmetrical Y joint for Ø16 - Ø18 - Ø20 spiral pipe	PVC	RACSPIR-YUNI	Ø16 - Ø18 - Ø20	20	1,82	
	PVC					
Giunto lineare per tubo spiralato Ø16 - Ø18 - Ø20 Linear joint for Ø16 - Ø18 - Ø20 spiral pipe	PVC	RACSPIR-GIU	Ø16 - Ø18 - Ø20	20	0,91	
	PVC					
Sifone per tubo spiralato Ø16 - Ø18 - Ø20 Syphon for spiral pipe Ø16 - Ø18 - Ø20	PVC	RACSPIR-SYPH	Ø16 - Ø18 - Ø20	10	2,91	
	PVC					
Tee per tubo spiralato Ø16 - Ø18 - Ø20 Tee derivation for spiral pipe Ø16 - Ø18 - Ø20	PVC	RACSPIR-TEE	Ø16 - Ø18 - Ø20	20	2,10	
	PVC					



**ACCESSORI
CONDIZIONAMENTO**

**ACCESSORIES FOR
CONDITIONING
SYSTEMS**

CANALINA PER TUBO SCARICO CONDENSA
DUCT FOR DRAIN PIPES

DESCRIZIONE DESCRIPTION	SPECIFICHE SPECIFICATION	CODICE ARTICOLO ARTICLE CODE	MISURA SIZE (mm)	Pz/Conf Pcs/Box	PREZZO PRICE (€)		
Canalina per Tubo scarico condensa	PVC Bianco	PROFILM2000-SPIR2525	25 X 25 L = 2000	32	3,13		
Duct for spiraled pipe	Pure-white PVC	PROFILM2000-SPIR3035	30 X 35 L = 2000	32	5,41		

NASTRI CONDIZIONAMENTO
CONDITIONING TAPES

DESCRIZIONE DESCRIPTION	SPECIFICHE SPECIFICATION	CODICE ARTICOLO ARTICLE CODE	MISURA SIZE (mm)	Pz/Conf Pcs/Box	PREZZO PRICE UNIT (€)	
Tape anticondensa nero Black anti-condensate tape	Gomma espansa Alta densità Retato Elastomeric foam High density Netted	TAPANTICOND-BL	50 x 3 L = 10 m	24	5,08	
Tape in alluminio Aluminium tape	Alluminio Aluminium	TAPALU-50	50 L = 50 m	24	9,80	
Tape anticondensa bianco White anti-condensate tape	Polietilene Polyethylene	TAPANTICOND-W*	50 x 3 L = 10 m	24	Chiedere prezzo	
Tape anticondensa nero rivestito in alluminio Black anticondensation tape	Gomma espansa nera rivestita con alluminio Black elastomeric foam aluminium coated	TAPANTICOND-ALU	50 x 3 L = 10 m	24	8,05	

TUBO SCARICO CONDENSA CORRUGATO CORRUGATED CONDENSATE DRAIN PIPE

DESCRIZIONE DESCRIPTION	SPECIFICHE SPECIFICATION	CODICE ARTICOLO ARTICLE CODE	MISURA SIZE (mm)	Pz/Conf Pcs/Box	PREZZO PRICE (€)	
*Tubo scarico condensa corrugato	In polipropilene bianco	SCARICOND18	Ø INT : 16 Ø EXT : 18 Rotolo da 50 m	1	49,80	
*Corrugated condensate drain pipe	White Polypropylene	SCARICOND20	Ø INT : 18 Ø EXT : 20 Rotolo da 50 m	1	59,20	



*Con innesti Maschio/Femmina distanziati ad ogni metro / With Male/Female connections at 1 mt range
** Non sono necessari accessori / No accessories needed

Tubo corrugato -
dettaglio innesto

Corrugated pipe -
Connection detail



VASCHETTA RECUPERO CONDENSA CONDENSATE BOX

DESCRIZIONE DESCRIPTION	SPECIFICHE SPECIFICATION	CODICE ARTICOLO ARTICLE CODE	MISURA SIZE (mm)	Pz/Conf Pcs/Box	PREZZO PRICE (€)	
Vaschetta recupero condensa Condensate box	In polipropilene Bianco seta - Scarico laterale Silk-White Polypropylene - lateral discharge	VASCHETTACOND03	430 x 50 x 108	25	8,10	
Vaschetta recupero condensa con sifone Condensate box with siphon	Uscita di scarico reversibile Completa di viti per fissaggio Reversible exhaust outlet Complete with screws for fixing	VASCHETTA-SIFONTEK	430 x 65 x 108	16	22,61	
Pipetta di scarico condensa con tappi Discharge pipette condensation with caps	Chiusura elastica a pressione PVC PVC Elastic pressure closure	PIPETEK-19	Ø 19	10	3,22	
		PIPETEK-32	Ø 32	10	4,41	

ACCESSORI
CONDIZIONAMENTO
ACCESSORIES FOR
CONDITIONING
SYSTEMS

**ACCESSORI
CONDIZIONAMENTO**

**ACCESSORIES FOR
CONDITIONING
SYSTEMS**

RACCORDERIA
FITTINGS

DESCRIZIONE DESCRIPTION	SPECIFICHE SPECIFICATION	CODICE ARTICOLO ARTICLE CODE	MISURA SIZE (Pollici / Inch)	Pz/Conf Pcs/Box	PREZZO PRICE UNIT (€)	
Dado	Ottone	DADO-14	1/4	10	0,96	
		DADO-38	3/8	10	1,36	
Nut	Brass	DADO-12	1/2	10	1,89	
		DADO-58	5/8	10	2,56	
Dado ridotto	Ottone	DADORID-3814	3/8 x 1/4	10	1,77	
		DADORID-1238	1/2 x 3/8	10	2,20	
Reduced nut	Brass	DADORID-5812	5/8 x 1/2	10	2,97	
Niples doppio Maschio/ maschio	Ottone	NIPLES-14	1/4	10	0,96	
		NIPLES-38	3/8	10	1,74	
Niples male/male	Brass	NIPLES-12	1/2	10	2,62	
Niples ridotto Maschio/ maschio	Ottone	NIPLESRID-1438	1/4 x 3/8	10	2,85	
		NIPLESRID-3812	3/8 x 1/2	10	3,68	
Reduced nipples male/male	Brass	NIPLESRID-1258	1/2 x 5/8	10	3,73	
Prolunga ridotta Maschio/ Femmina	Ottone	PROLRID-1438	M 1/4 x F 3/8	10	2,43	
		PROLRID-1412	M 1/4 x F 1/2	10	2,74	
		PROLRID-3814	M 3/8 x F 1/4	10	2,97	
Reduced extension male/female	Brass	PROLRID-3812	M 3/8 x F 1/2	10	3,44	
		PROLRID-1238	M 1/2 x F 3/8	10	3,45	

ACCESSORI PER CONDIZIONAMENTO ACCESSORIES FOR AIR CONDITIONING SYSTEMS



GROPPALLI
FLUE SYSTEMS
DISTRIBUZIONE

DESCRIZIONE DESCRIPTION	SPECIFICHE SPECIFICATION	CODICE ARTICOLO ARTICLE CODE	MISURA SIZE (Pollici / Inch)	Pz/Conf Pcs/Box	PREZZO PRICE UNIT (€)	
Curva 90° Maschio/ maschio 90° elbow male/male	Ottone	CURVA90-14	1/4	10	3,18	
		CURVA90-38	3/8	10	3,85	
	Brass	CURVA90-12	1/2	10	6,60	
		CURVA90-58	5/8	10	9,21	
Tappo cieco femmina Female cap	Ottone	TAPPOCIECO-14	1/4	10	0,81	
		TAPPOCIECO-38	3/8	10	1,77	
	Brass	TAPPOCIECO-12	1/2	10	1,84	
		TAPPOCIECO-58	5/8	10	3,29	
Guarnizione conica Conical gasket	Rame	GUARNIZIONE-14	1/4	10	0,12	
		GUARNIZIONE-38	3/8	10	0,24	
	Copper	GUARNIZIONE-12	1/2	10	0,28	
		GUARNIZIONE-58	5/8	10	0,36	
Raccordo ad inversione Reversed fittings	Rame	INVERSIONE-14	1/4	10	8,51	
		INVERSIONE-38	3/8	10	12,00	
	Copper	INVERSIONE-12	1/2	5	14,50	

**ACCESSORI
CONDIZIONAMENTO**
ACCESSORIES FOR
CONDITIONING
SYSTEMS