



GROPPALLI

catalogo persiane e scuri







## COLORI STANDARD (senza maggiorazione)

Ral 6009 opaco

Ral 9010 opaco

Ral 6005 ruvido

Verde marezzato

Ral 6005 opaco

Ral 1013 opaco

Ral 8017 ruvido

Marrone marezzato

Ral 8017 opaco

Ral 7001 opaco

Ral 7001 ruvido

Grigio marezzato

Ral 7035 opaco

Ral 6021 opaco

Ral 6009 ruvido

## COLORI EFFETTO LEGNO

con maggiorazione minima **+18%**

R809 Renolit oro

R811 Renolit scuro

con maggiorazione minima **+20%** - POLVERE SU POLVERE

W640 Wengè

GH30 Legno verde

N530 Ciliegio Antico

N632 Noce reale

R500 Rovere

con maggiorazione minima **+25%** - SUBLIMATI

N101R Noce scuro rag.

NC77R Noce canaletto

C317R Ciliegio Fiam. Rag.

C307R Ciliegio chiaro Fiam. Rag.

RC90R Renolit Cezanne

# CERTIFICAZIONI

## **Continui controlli per un prodotto ai massimi standard**

Per rispondere correttamente all'evoluzione del mercato, Gropalli consegue nel 1996 la certificazione **ISO 9002:1994** (Lloyd's Register) e nel 2002 diventa una delle prime imprese italiane ad ottenere la certificazione **ISO 9001:2000** (Lloyd's Register).

Ad oggi tutti i prodotti commercializzati sono sottoposti a rigorosi controlli qualitativi oltre ad esser marcati CE.

Ogni prodotto nasce dal coraggio e dall'ambizione di chi fa del progresso il proprio mestiere. L'intero ciclo produttivo è basato su un livello tecnologico assoluto. Ogni prodotto è progettato, sperimentato e messo a punto nel Centro Ricerca e Sviluppo. Inoltre da diversi anni Gropalli collabora con Università, enti e laboratori sviluppando progetti in ambito di ricerca energetica ed ecosostenibilità.



## **Il coraggio delle proprie idee**

L'avventura imprenditoriale della Gropalli nasce negli anni '70 come piccola azienda produttrice di stampi a conduzione familiare. Sono anni di sacrifici, lavoro e impegno che getteranno le basi per lo sviluppo di quelle competenze tecniche in grado di trasformare la Gropalli in un'azienda leader.



### GROPALLI ITALIA

Cuore produttivo e centro decisionale del gruppo, si sviluppa su una superficie di 35.000 m<sup>2</sup> ed è dotata delle più moderne tecnologie di produzione atte a consentire la risposta a qualsiasi esigenza del cliente.

Ogni scelta è guidata dall'ambizione di garantire costantemente la massima qualità e affidabilità del prodotto oltre ad un servizio tecnico-commerciale efficiente per il cliente.

### GROPALLI LOGISTICA

Nel 2008 è stato ampliato il centro logistico che rivoluziona il modo di concepire il rapporto cliente-fornitore. In particolare, grazie al suo magazzino automatico da 37.000 posti pallets, Gropalli è in grado di ridurre al minimo la filiera produttiva consegnando rapidamente, quello che serve, dove serve, nell'esatta quantità che serve.

### GROPALLI TURCHIA

Avviata nel 2006 per servire direttamente il mercato turco oggi possiede uno stabilimento di 10.000 m<sup>2</sup>. Nel 2010 nasce G.ALL per fornire il gruppo e il mercato interno di profili di alluminio per svariati settori, tra cui quello di serramenti, zanzariere ecc.

### MG TRANCERIA

Azienda del gruppo Gropalli, specializzata nella trasformazione e lavorazione della lamiera, in particolare tranciatura, imbutitura e piegatura.

### GROPALLI HVAC

L'ultima nata del gruppo si trova a Chang Zhou, Cina. L'azienda, operativa dal 2015, con i suoi 20.000 m<sup>2</sup> porta in oriente la qualità del prodotto Gropalli realizzato in loco secondo gli standard Europei e le caratteristiche che contraddistinguono il made in Italy.



# Tipologie di Aperture per Antoni e Persiane



catalogo  
persiane e scuri

1

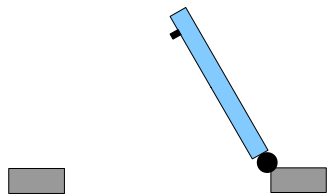

Un'anta SPINGERE DESTRA

2

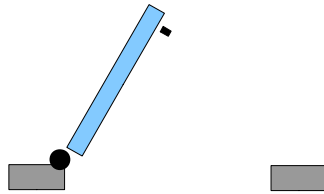

Un'anta SPINGERE SINISTRA

3

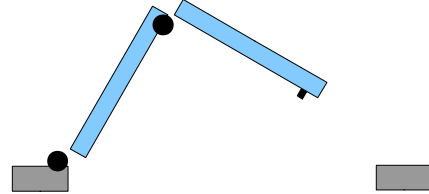

Due ante a libro, cerniera interna  
apertura SPINGERE A SINISTRA

4

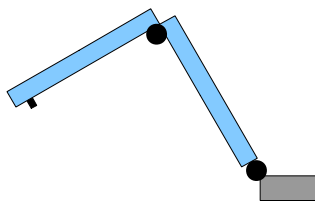

Due ante a libro, cerniera interna  
apertura SPINGERE A DESTRA

5

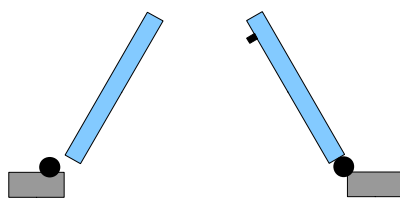

Due ante SPINGERE DESTRA

6

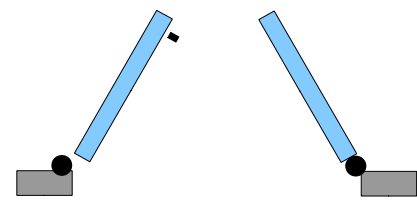

Due ante SPINGERE SINISTRA

7

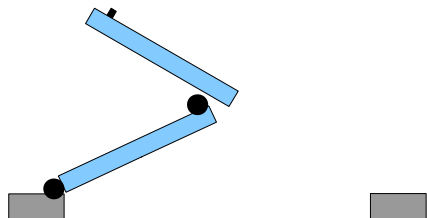

Due ante a libro, cerniera esterna  
apertura SPINGERE A SINISTRA

8

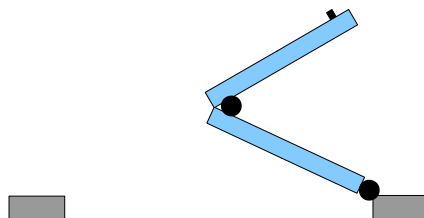

Due ante a libro, cerniera esterna  
apertura SPINGERE A DESTRA

9

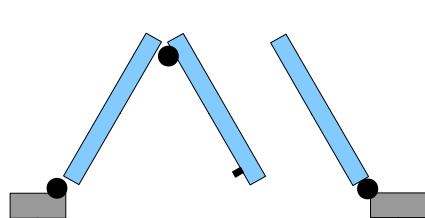

Tre ante a libro, cerniera interna  
apertura SPINGERE A SINISTRA  
Spagnoletta di chiusura su ante  
pieghevoli

10

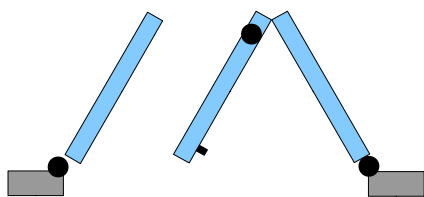

Tre ante a libro, cerniera interna  
apertura SPINGERE A DESTRA  
Spagnoletta di chiusura su ante  
pieghevoli

11

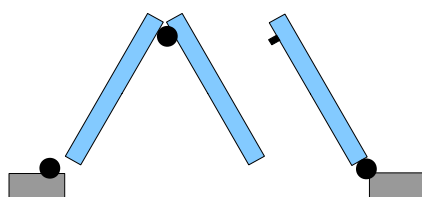

Tre ante a libro, cerniera interna  
apertura SPINGERE A DESTRA  
Spagnoletta di chiusura su anta  
battente

12

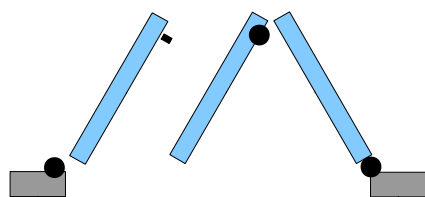

Tre ante a libro, cerniera interna  
apertura SPINGERE A SINISTRA  
Spagnoletta di chiusura su anta  
battente

13

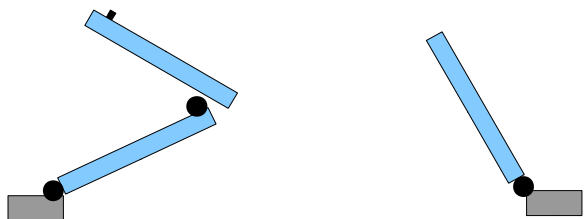

Tre ante a libro, cerniera esterna apertura  
SPINGERE A SINISTRA  
Spagnoletta di chiusura su anta pieghevoli

14

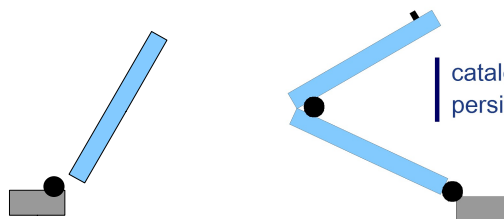

Tre ante a libro, cerniera esterna apertura  
SPINGERE A DESTRA  
Spagnoletta di chiusura su anta pieghevoli



catalogo  
persiane e scuri

15

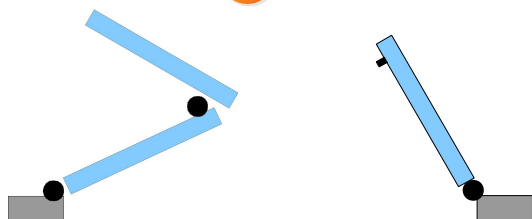

Tre ante a libro, cerniera esterna apertura  
SPINGERE A DESTRA  
Spagnoletta di chiusura su anta battente

16

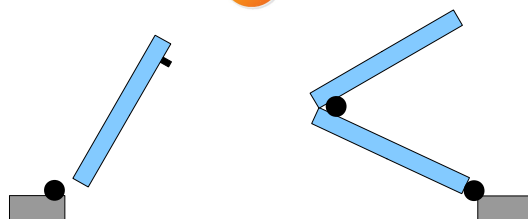

Tre ante a libro, cerniera esterna apertura  
SPINGERE A SINISTRA  
Spagnoletta di chiusura su anta battente

17

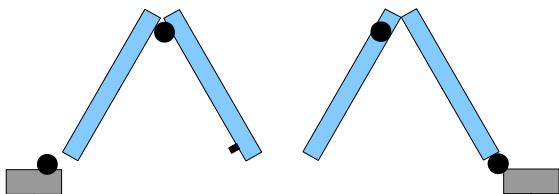

Quattro ante a libro, cerniera interna apertura  
SPINGERE A SINISTRA  
Spagnoletta di chiusura su prima anta  
ripieghevole SX

18

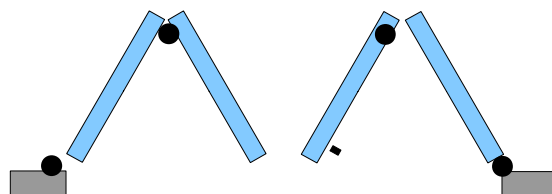

Quattro ante a libro, cerniera interna apertura  
SPINGERE A DESTRA  
Spagnoletta di chiusura su prima anta  
ripieghevole DX

19

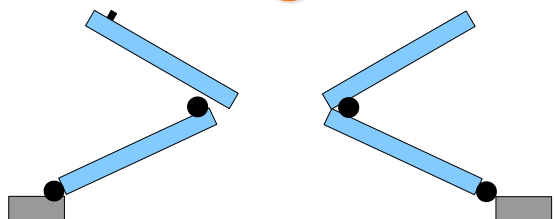

Quattro ante a libro, cerniera esterna apertura  
SPINGERE A SINISTRA  
Spagnoletta di chiusura su prima anta  
ripieghevole SX

20

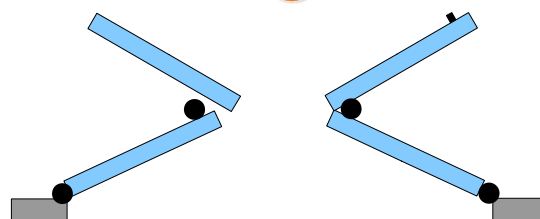

Quattro ante a libro, cerniera esterna apertura  
SPINGERE A DESTRA  
Spagnoletta di chiusura su prima anta  
ripieghevole DX

21

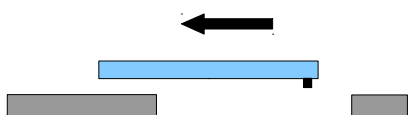

Anta scorrevole SINISTRA esterna

22

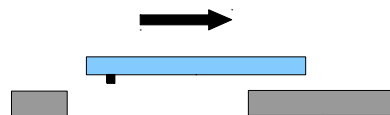

Anta scorrevole DESTRA esterna

## Persiane in alluminio a stecca fissa

## Sezione verticale:

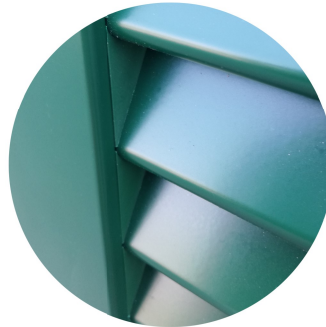

Colorazioni selle disponibili a magazzino:

RAL1013	RAL6005	RAL6009
RAL7001	RAL8003	RAL8017
RAL9005	RAL9010	

Altri colori disponibili a richiesta:

RAL1006	RAL1019	RAL6021
RAL7032	RAL7044	RAL8014
RAL9007		

La persiana *Margherita* ha la caratteristica di avere le lamelle tonde fisse da 50mm in posizione inclinata, separate tra loro da appositi distanziali in nylon disponibili in diverse colorazioni. Il posizionamento obliquo della lamella consente una illuminazione soffusa degli ambienti evitando l'entrata diretta dei raggi del sole, proteggendo anche da sguardi indiscreti, il tutto abbinato ad un'efficace ventilazione. Gli zoccoli a forma piana disponibili in diverse dimensioni sono incastonati a 90° nella persiana. La persiana può essere incardinata direttamente al muro, in alternativa può essere realizzata anche con telaio di cassa perimetrale. Sono realizzabili tipologie finestra e porta finestra ad una o più ante anche nelle soluzioni a libro.

## Sezione orizzontale:

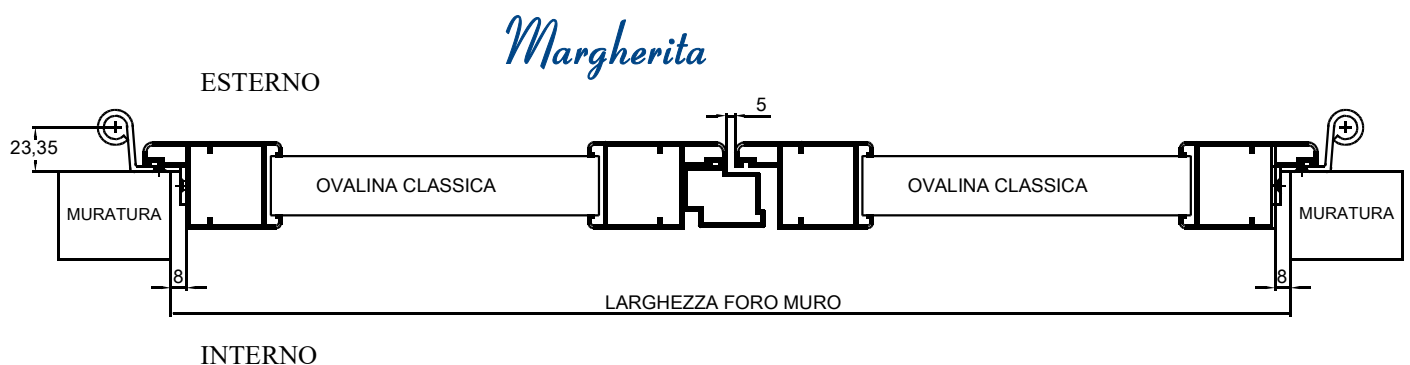

## Profili per persiane in alluminio a stecca fissa

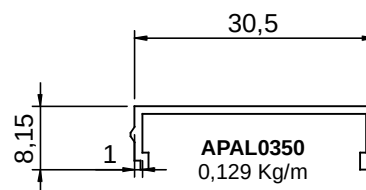
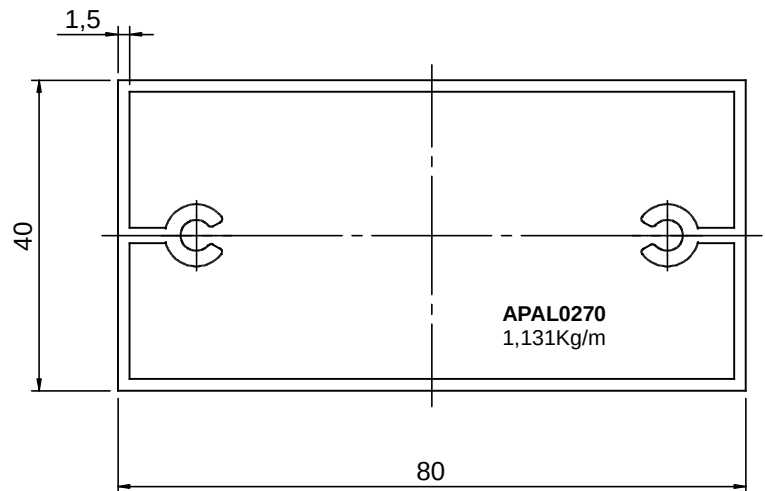
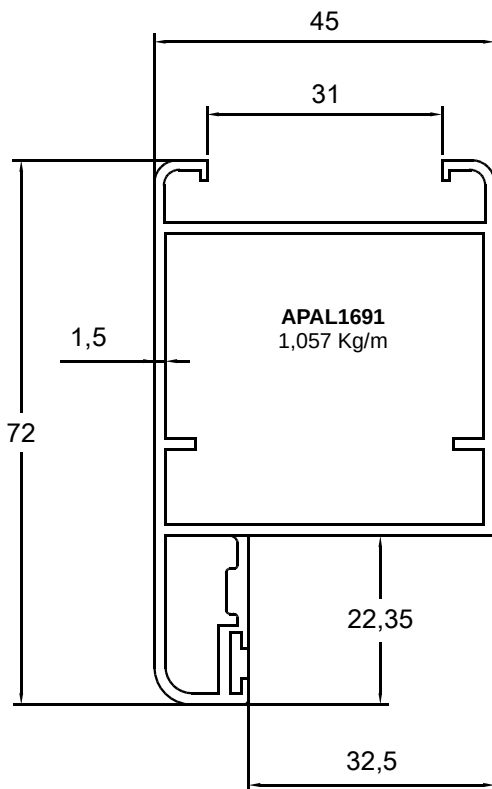
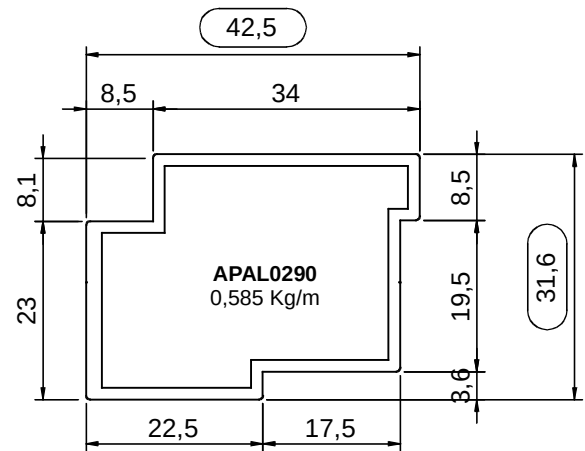
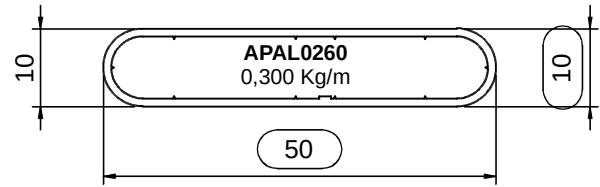
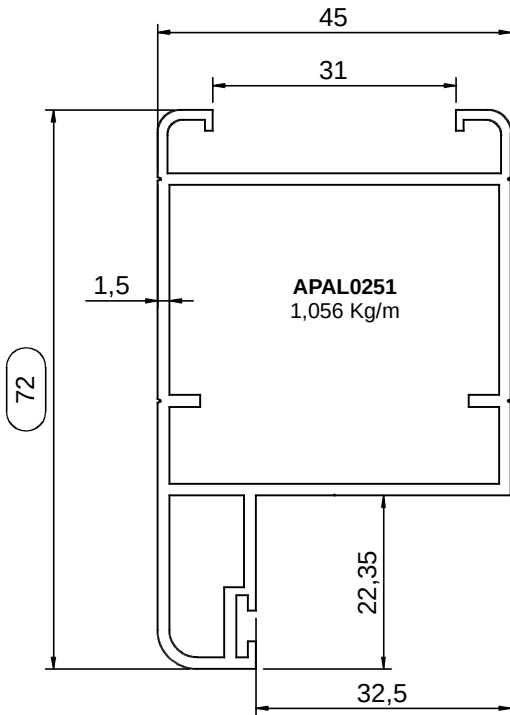



## Persiane ovaline fisse cieche

## Sezione verticale:



Vista Esterna



Vista Interna



La persiana *Ninfea* si caratterizza per le lamelle ovali cieche, inserite nella struttura portante della persiana. La *Ninfea* appare esternamente come il nostro mod. *Margherita*, mentre all'interno rimane un oscuramento quasi totale.

La persiana può essere incardinata direttamente al muro, in alternativa può essere realizzata anche con telaio di cassa perimetrale. Sono realizzabili tipologie finestra e porta finestra ad una o più ante anche nelle soluzioni a libro.

## Sezione orizzontale:

*Ninfea*

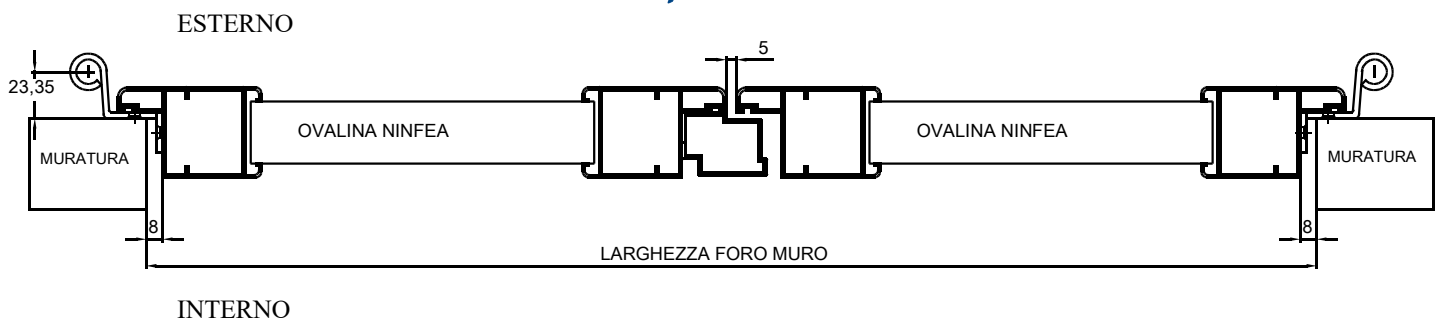

## Profili per persiane ovaline fisse cieche

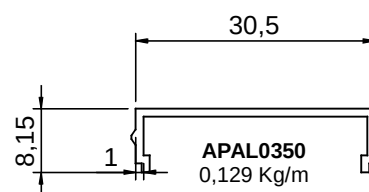
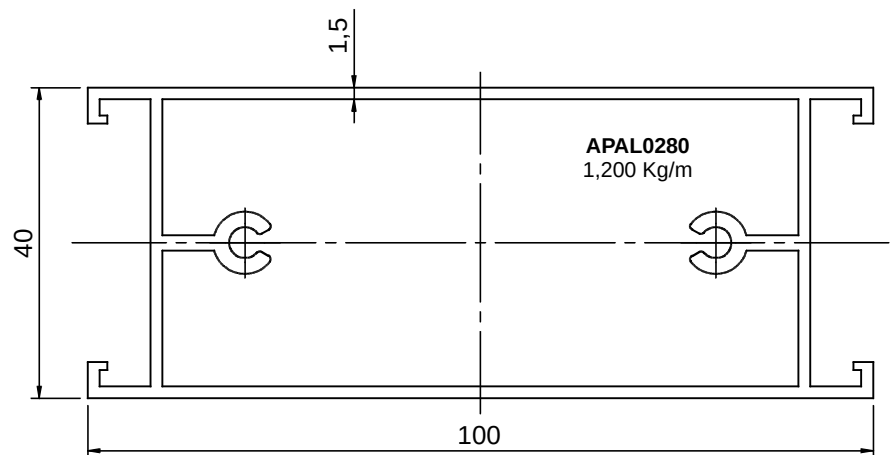
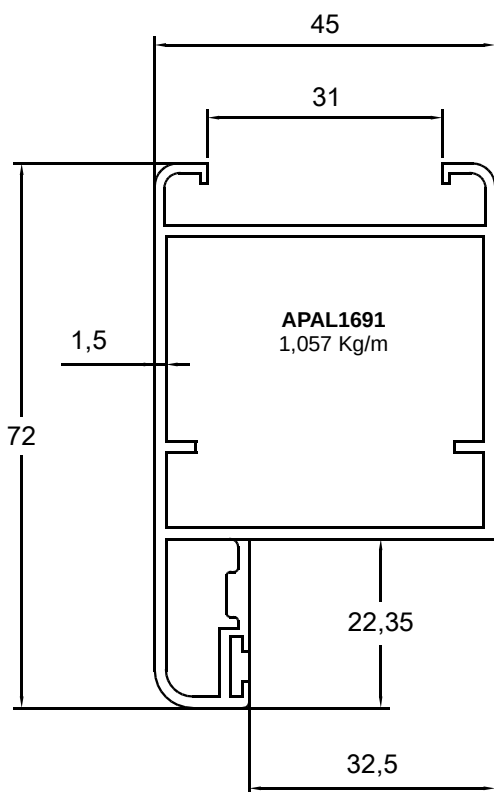
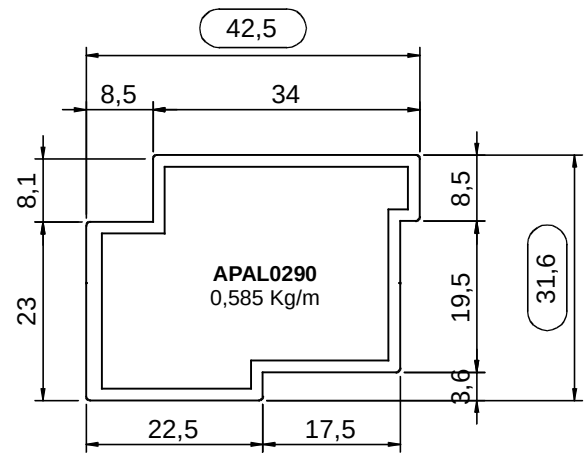
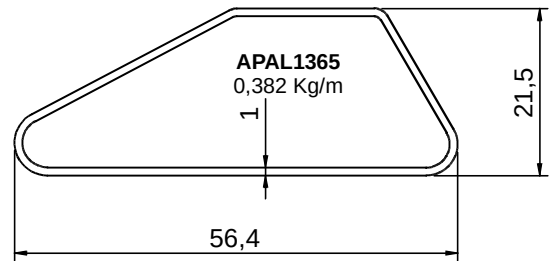
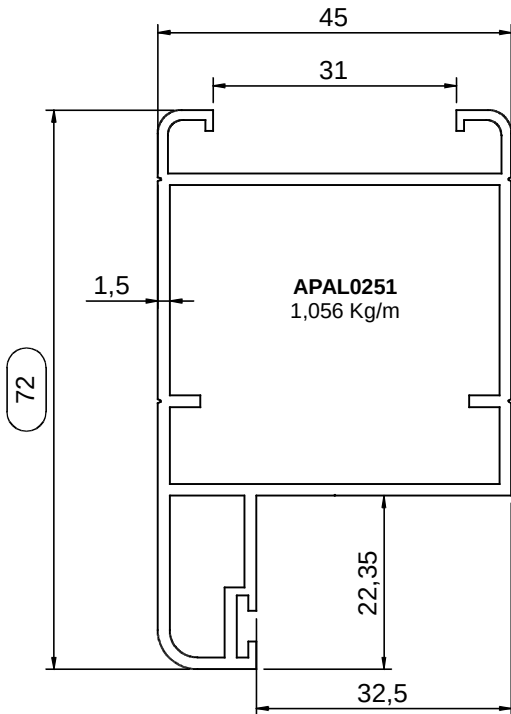

## Persiane in alluminio a stecca orientabile



### Sezione verticale:

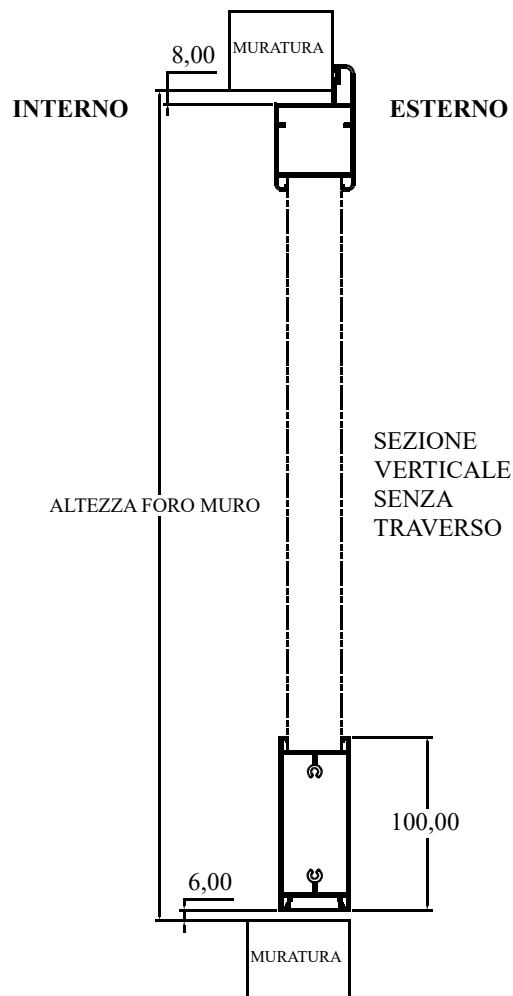

Meccanismi orientabili standard NERI

A RICHIESTA Meccanismi orientabili con sovrapprezzo IN TINTA

La persiana *Girasole* dispone di un particolare sistema di movimentazione tra le lamelle che permette una regolazione manuale del passaggio di luce fino a un oscuramento quasi totale.

L'orientamento delle lamelle favorisce le operazioni di pulizia delle persiane. Grazie all'eccezionale affidabilità e manovrabilità dei meccanismi l'orientamento risulta fluido e silenzioso. La forma a goccia della lamella inoltre ne caratterizza l'impiego in particolari stili architettonici. Disponibile in versione incardinata direttamente a muro o con telaio di cassa perimetrale.

### Sezione orizzontale: *Girasole*

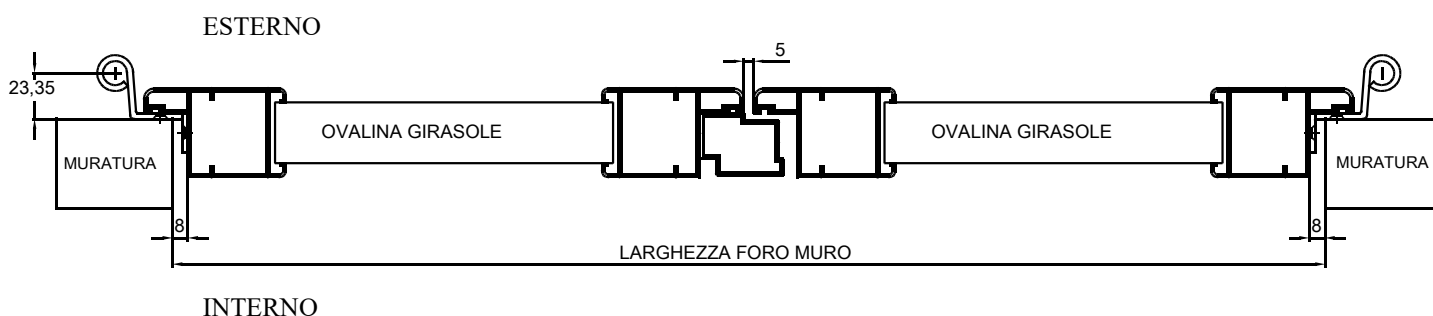

## Profili per persiane in alluminio a stecca orientabile

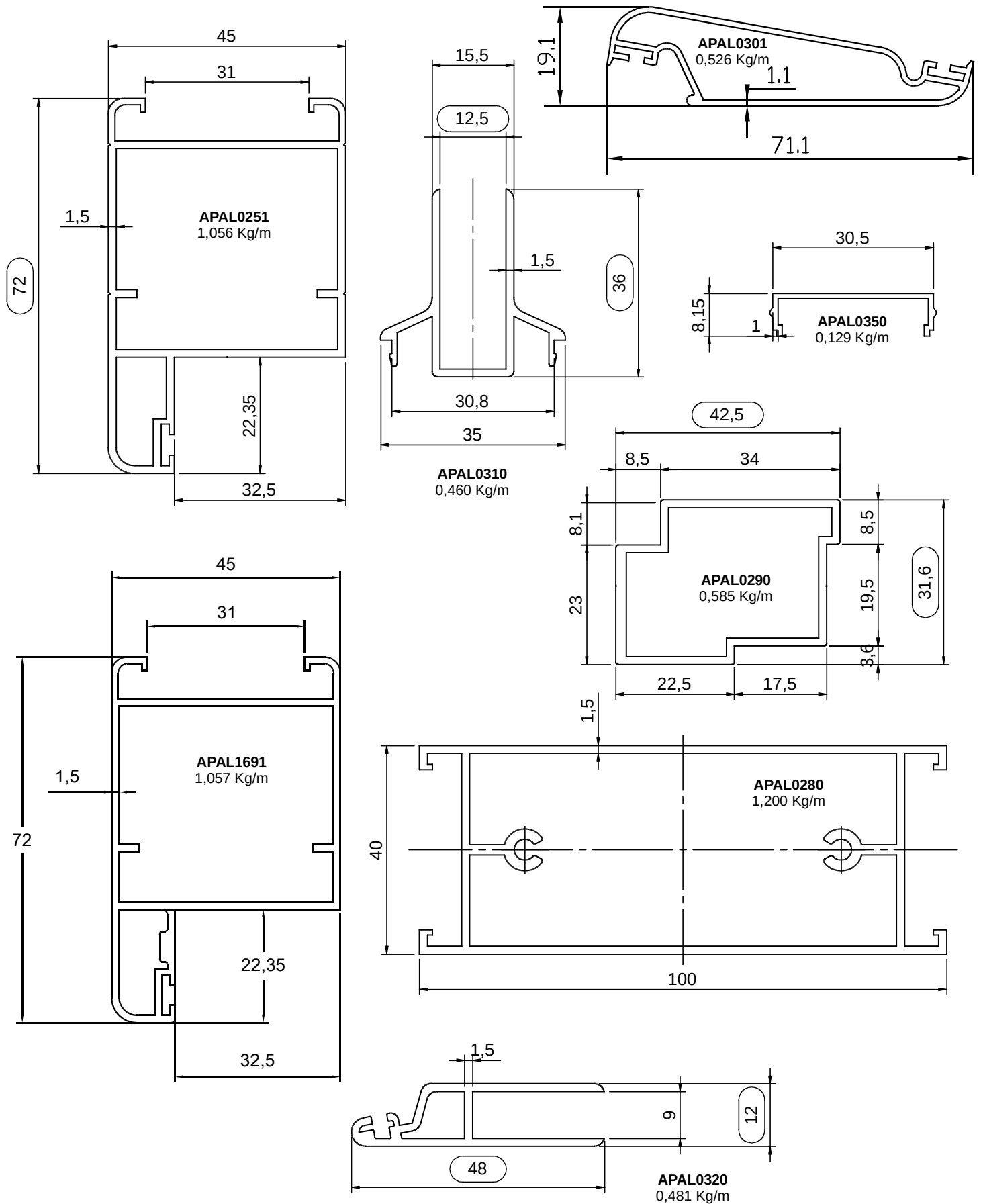

## Persiane modello Genovese

Disponibile sia nella versione a stecca fissa che a stecca orientabile



La persiana *Ginestra* si differenziano dalle persiane tradizionali per la presenza dello “sportellino apribile verso l'esterno” vincolate da cerniere in alluminio di nuova concezione tecnologica. Tamponamento delle ante mobili eseguito con ovaline di tipo tradizionale fisso. Disponibile in versione incardinata direttamente a muro o con telaio di cassa perimetrale.

### Sezione orizzontale:

*Ginestra*

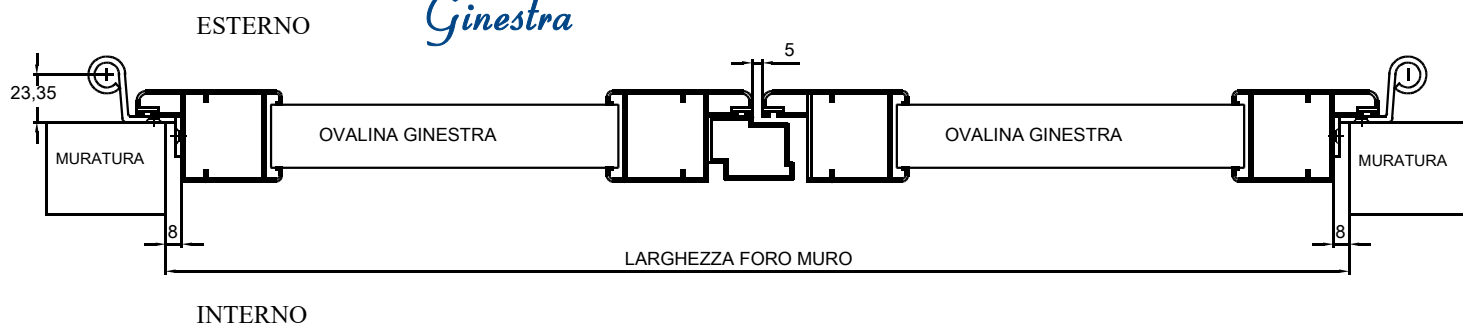

## Persiane modello Storica

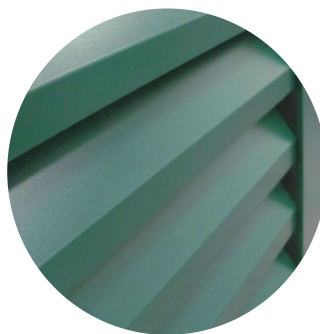
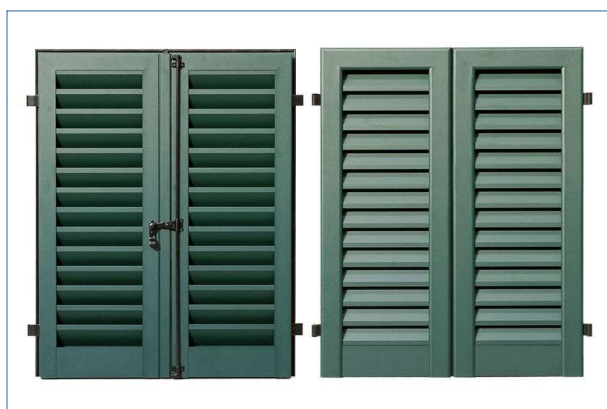

## Sezione verticale:

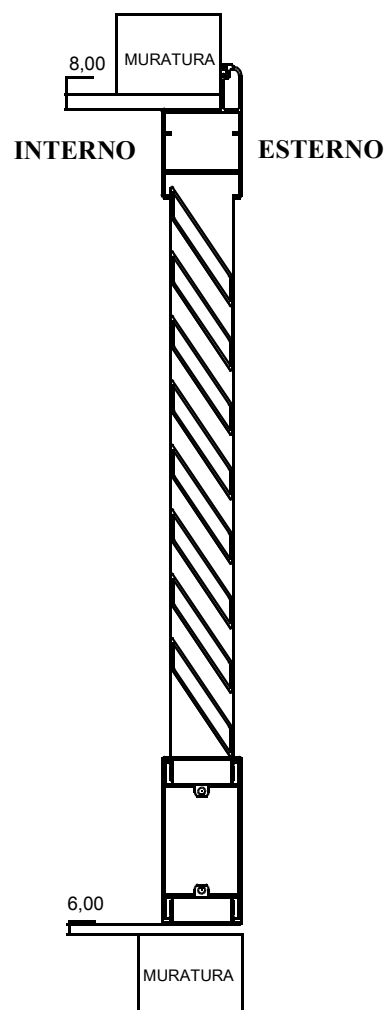

La persiana *Quercia* dispone di un particolare sistema di aggancio tra le lamelle che permette un' assoluta protezione dalla luce, dalla polvere e dagli agenti atmosferici.

Le ovaline sono estruse in alluminio con aspetto simile alle "vecchie" persiane in legno di tipo storico. Questa persiana è adatta per ristrutturazioni d'epoca più esigenti o per i progetti conservativi dei centri storici garantendo un'architettura che convoglia insieme il gusto moderno e lo stile antico. Può essere fornita anche con una cornice inserita a riporto sull'anta mobile perimetrale.

## Sezione orizzontale:

### Quercia

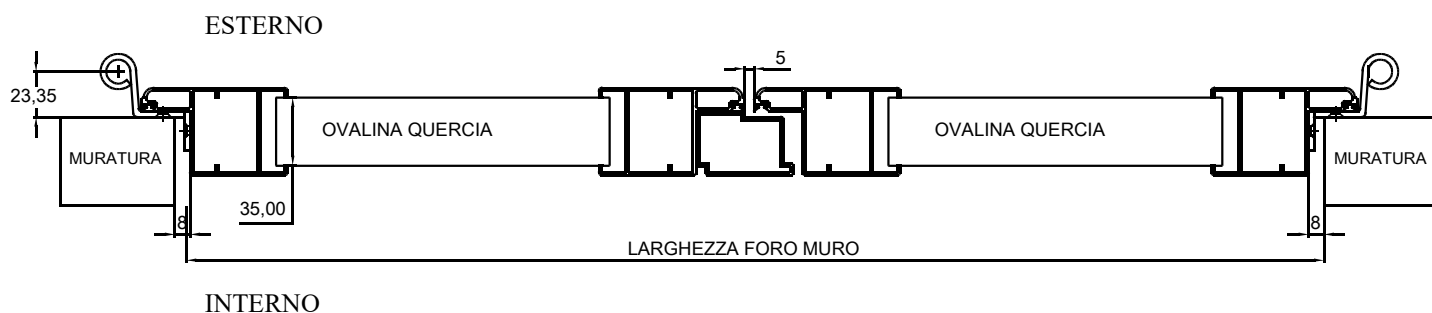

## Profili per persiane in alluminio modello storica

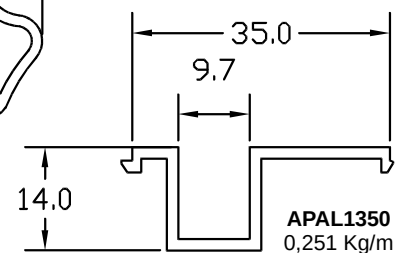
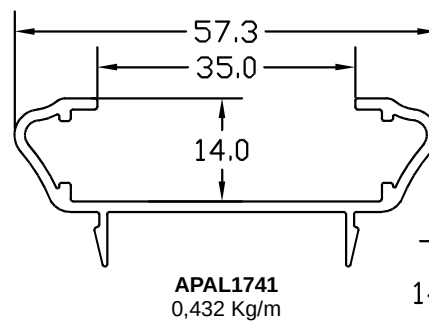
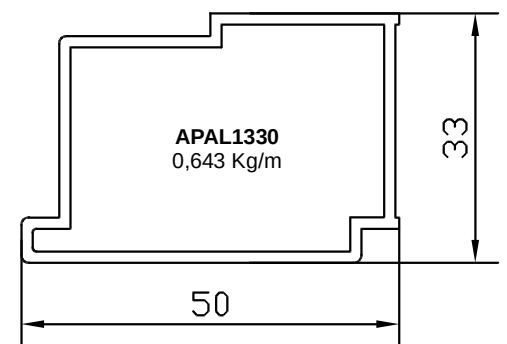
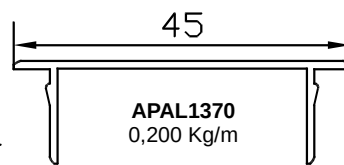
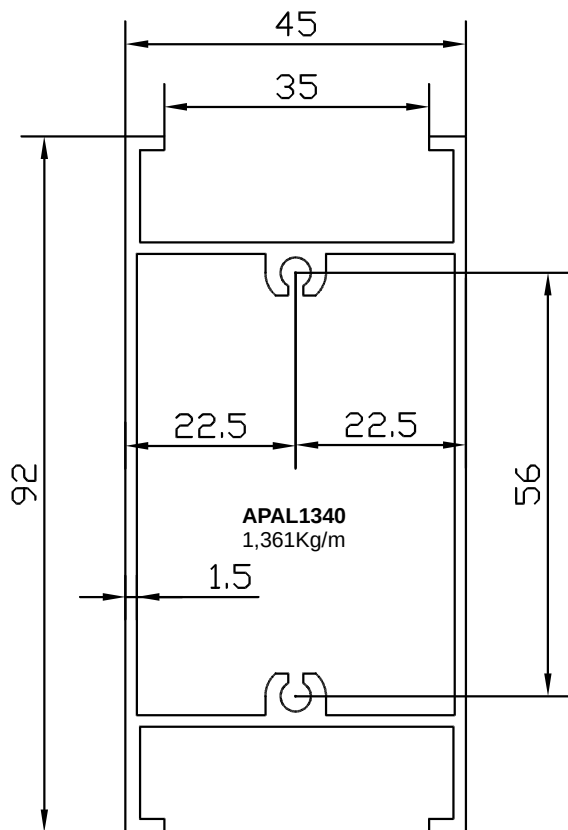
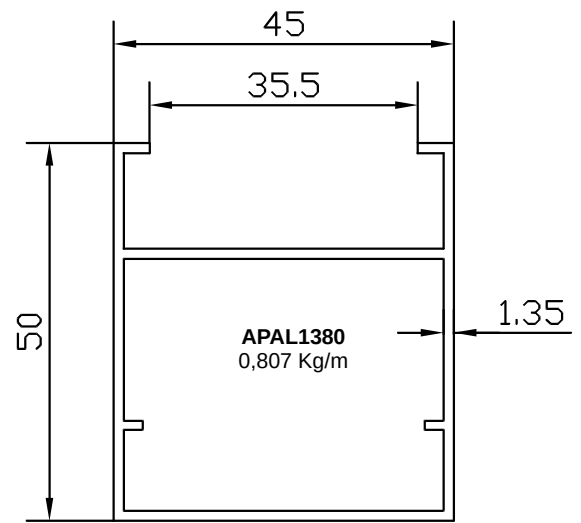
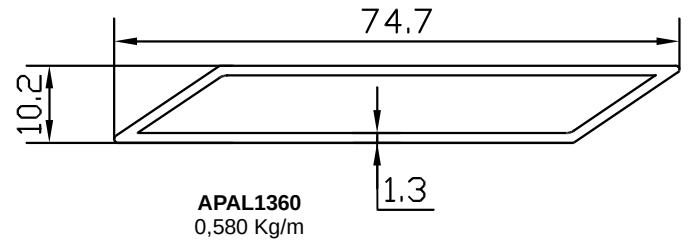
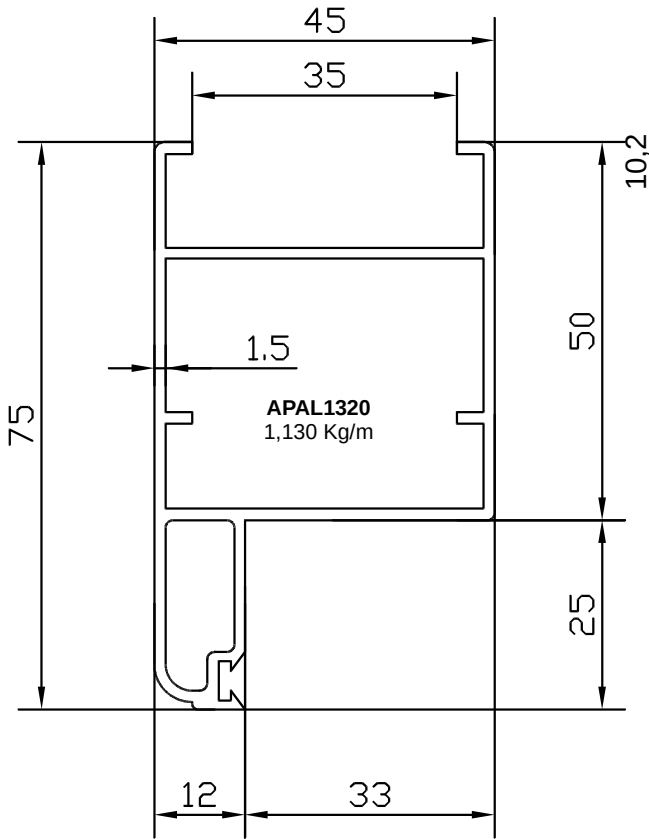

# Glicine

## Frangisole



catalogo  
persiane e scuri



### Sezione verticale:

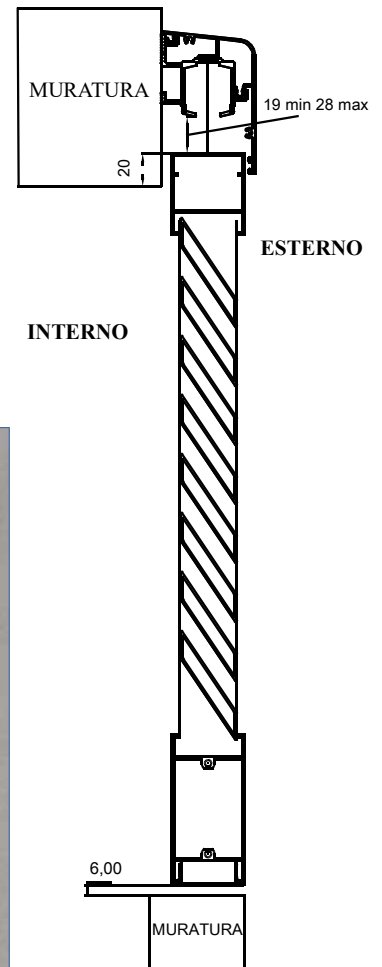

Realizzata con l'ovalina storica, il frangisole è perfetto per balconi, giardini e tetti, come soluzione per proteggere dal sole, dal vento dalle intemperie, con una struttura leggera e colorata a piacimento. Il frangisole permette il passaggio della luce in maniera poco invasiva, con un'architettura moderna e allo stesso tempo in armonia con l'ambiente esterno.

### Sezione orizzontale:

# Glicine

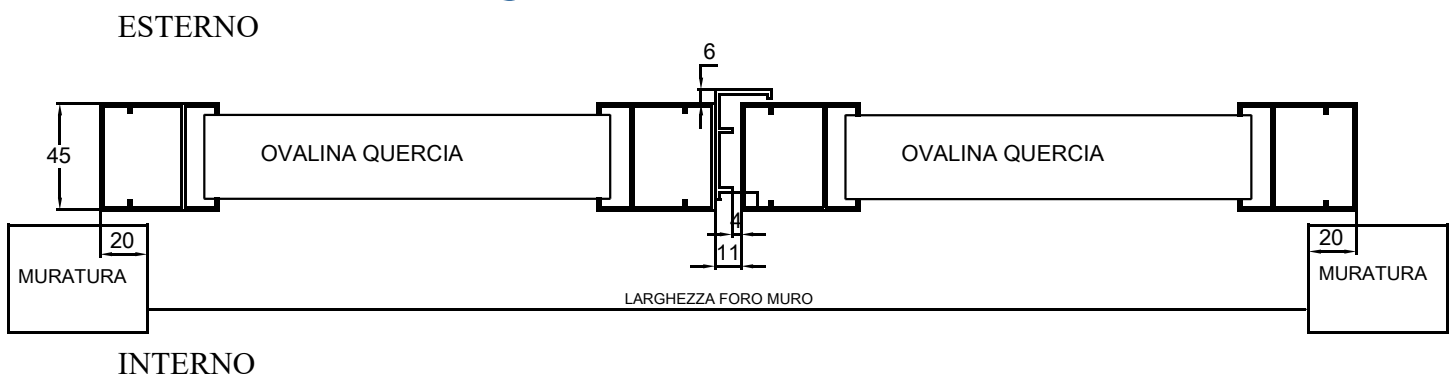



## Antone in alluminio



### Sezione verticale:



L' antone *Cedro* può esser realizzato con doghe verticali o orizzontali (largh.110mm-spess28mm). Sono realizzabili tipologie a finestra e portafinestra ad una o più ante anche nella soluzione libro. Disponibile in versione incardinata a muro o con telaio di cassa perimetrale.

### Sezione orizzontale:

*Cedro*

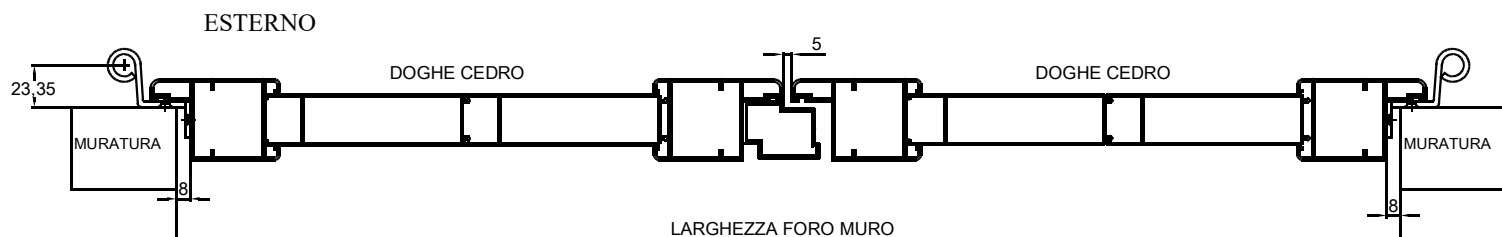

## Profili per antoni in alluminio

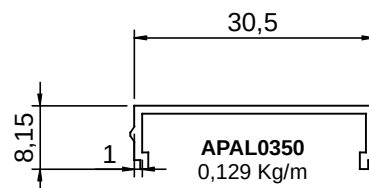
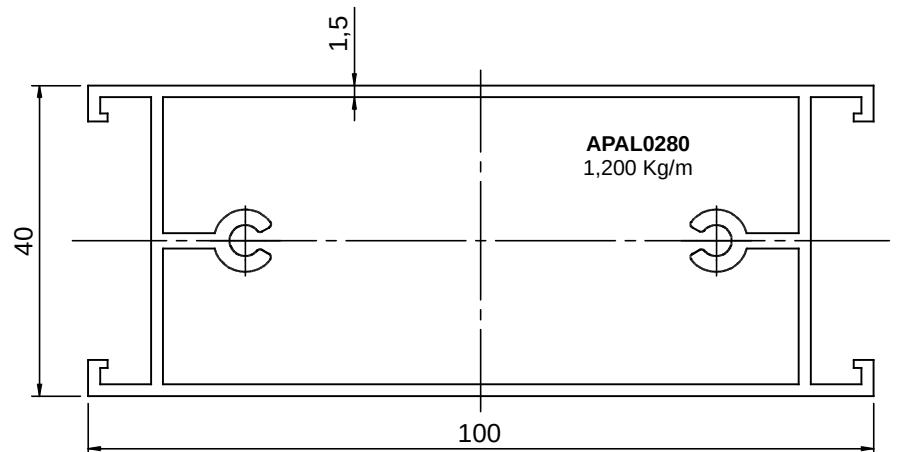
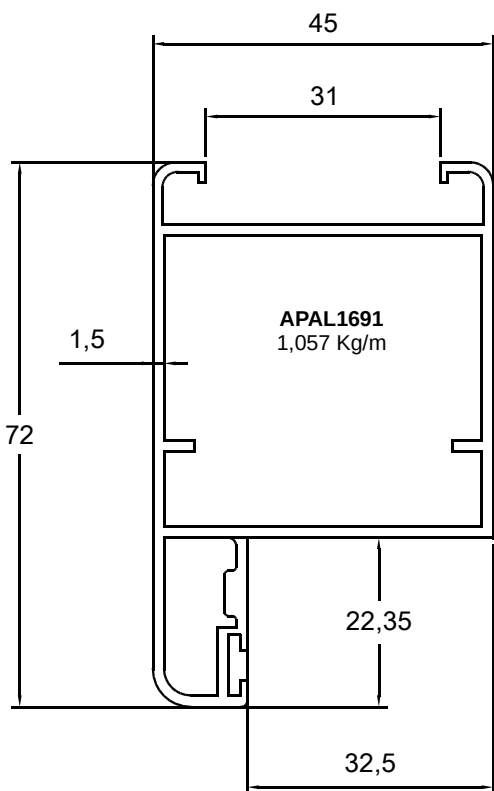
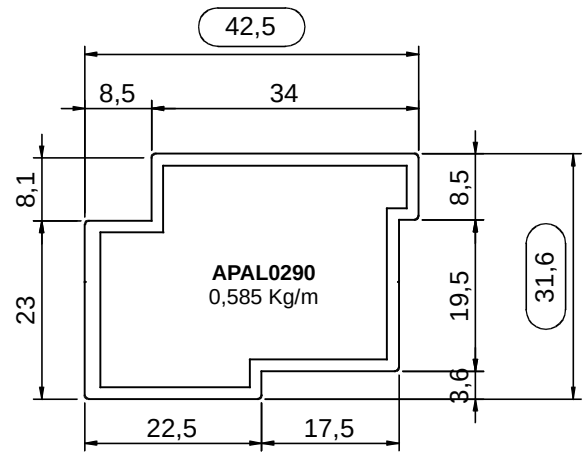
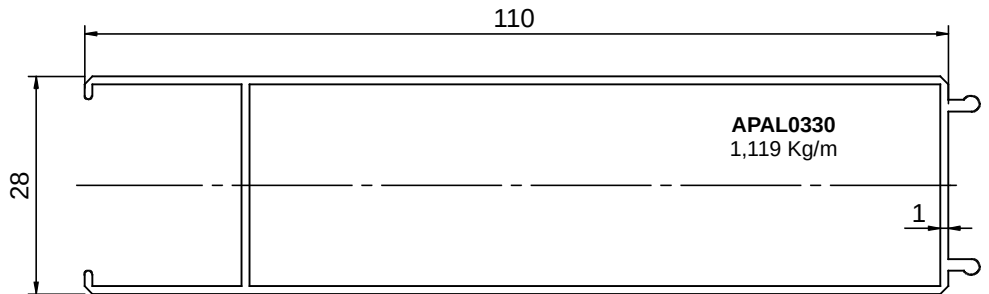
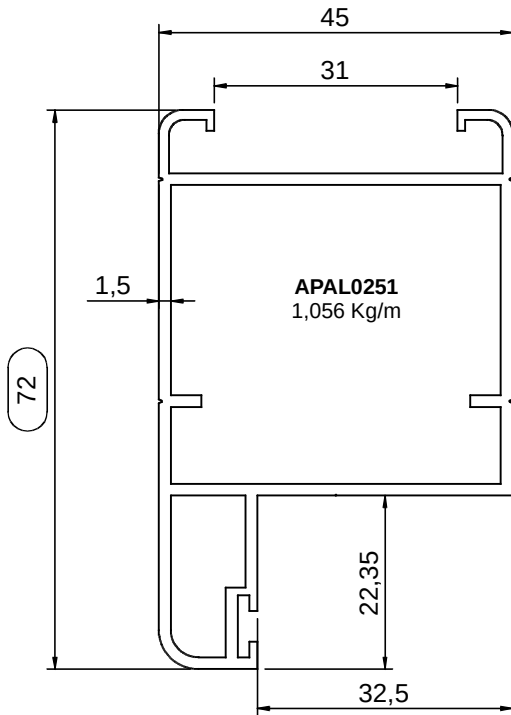

## Antone in alluminio



## Sezione verticale:



Vista Esterna



Vista Interna

L' antone *Faggio* caratterizzato da doghe verticali o orizzontali (larghezza 80mm - spessore 8mm) in vista sia nella parte interna che esterna. La struttura portante è molto più leggera e sottile rispetto altri modelli.

Sono realizzabili tipologie a finestra e portafinestra ad una o più ante anche nella soluzione libro. Disponibile in versione incardinata a muro o con telaio di cassa perimetrale.

## Sezione orizzontale:

*Faggio*

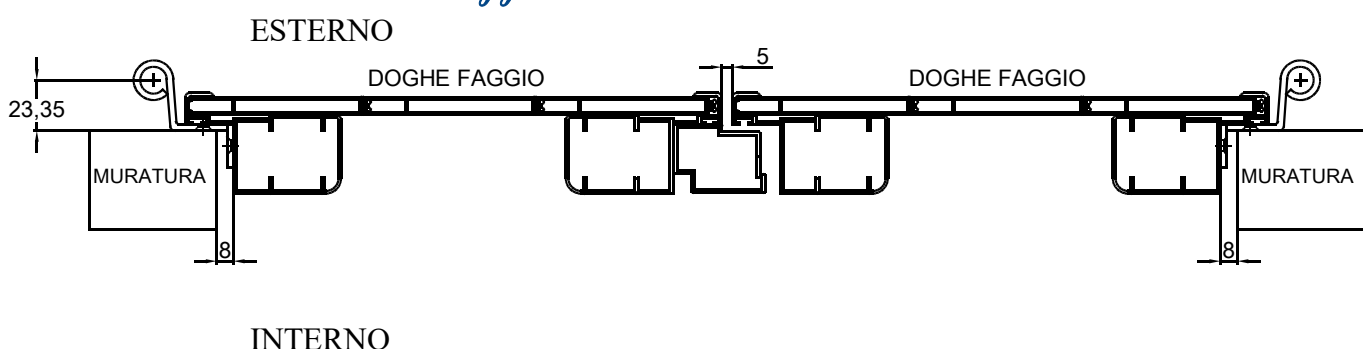

## Profili per antoni leggero in alluminio

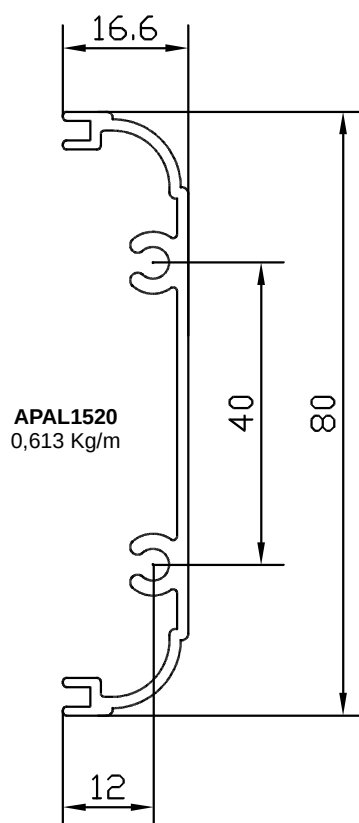
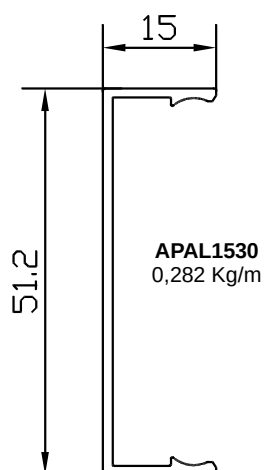
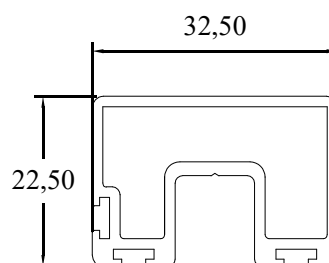
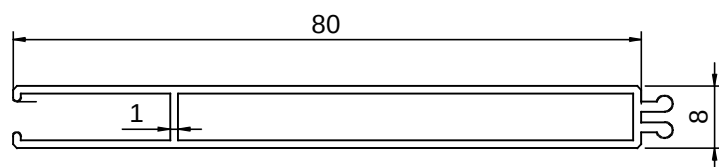
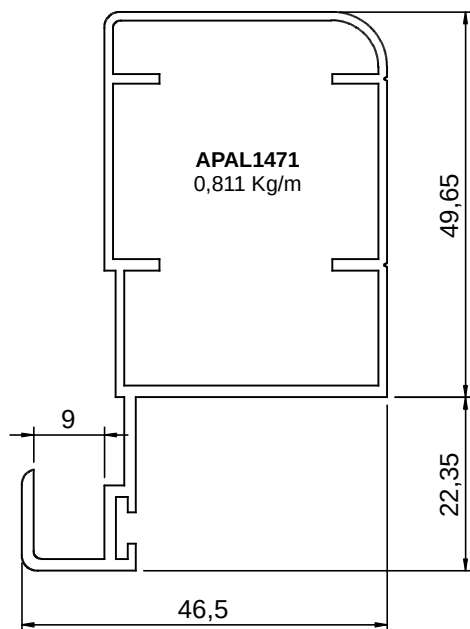

## Antone mod. Scandola

## Sezione verticale:



Foto puramente indicative



Il *Castagno* è il classico scuro alla “mantovana” che riporta fedelmente le forme dei vecchi scuri in legno dai quali eredita le caratteristiche. Realizzato con le doghe verticali/orizzontali esterne o interne a piacimento. Fotografato nella versione con cardini a muro lo scuro, può essere realizzato anche con telaio di cassa perimetrale. Questo modello realizzato con finitura legno ha un aspetto massiccio ed elegante.

## Sezione orizzontale:

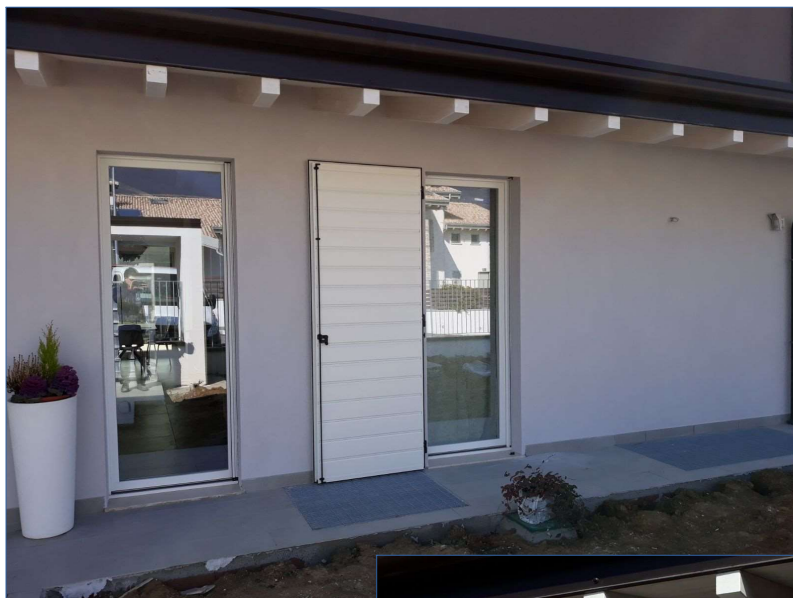
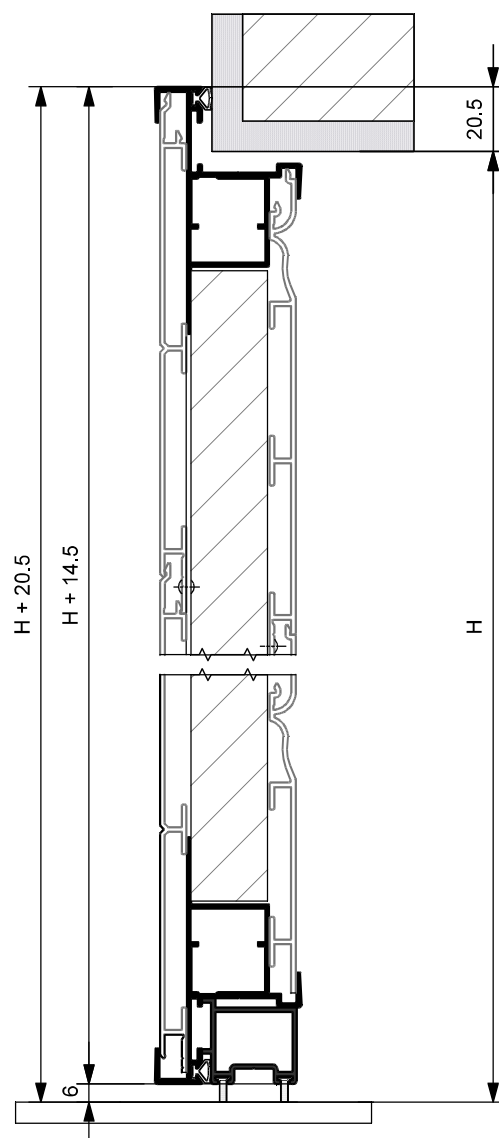
### *Castagno*

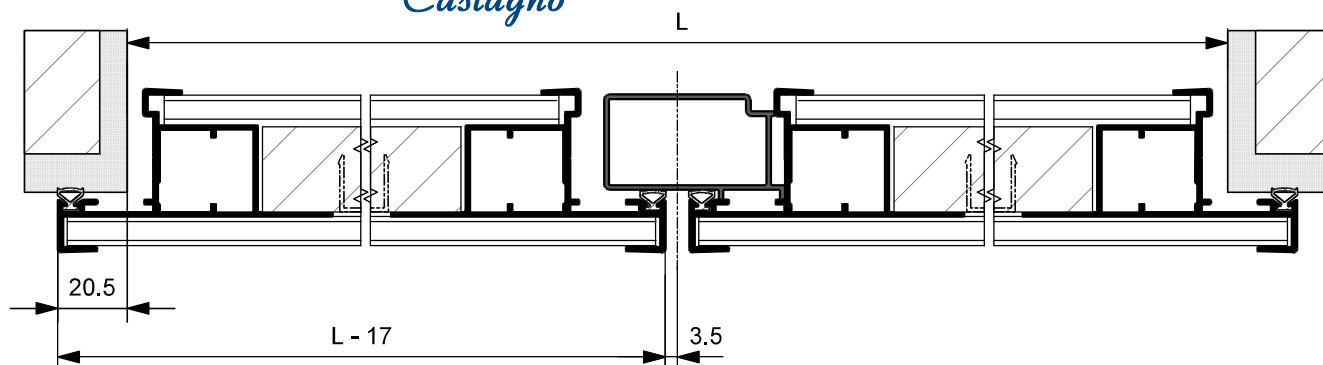

## Profili per scandola

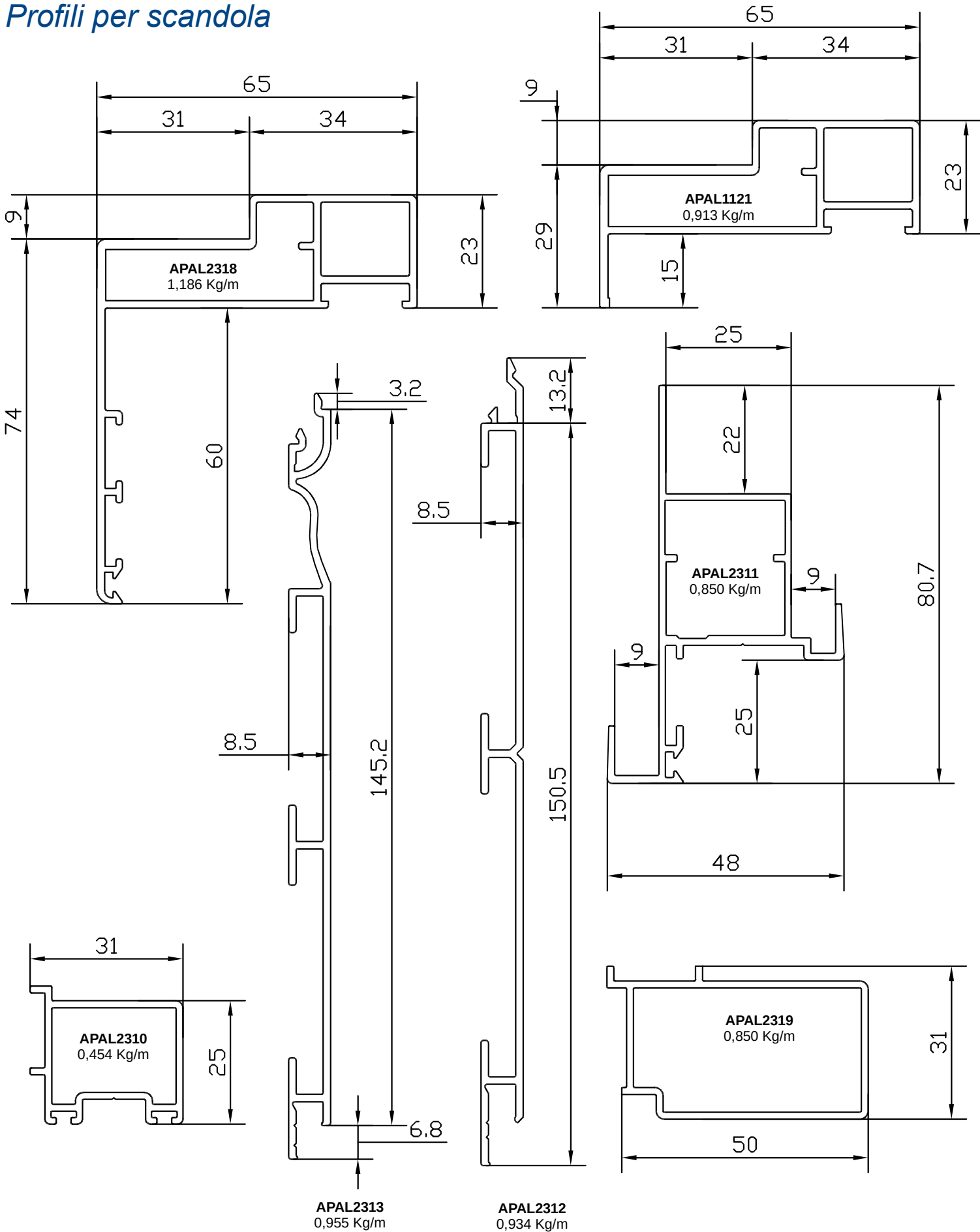

## Persiane in alluminio scorrevole



Dettaglio

## Sezione verticale:

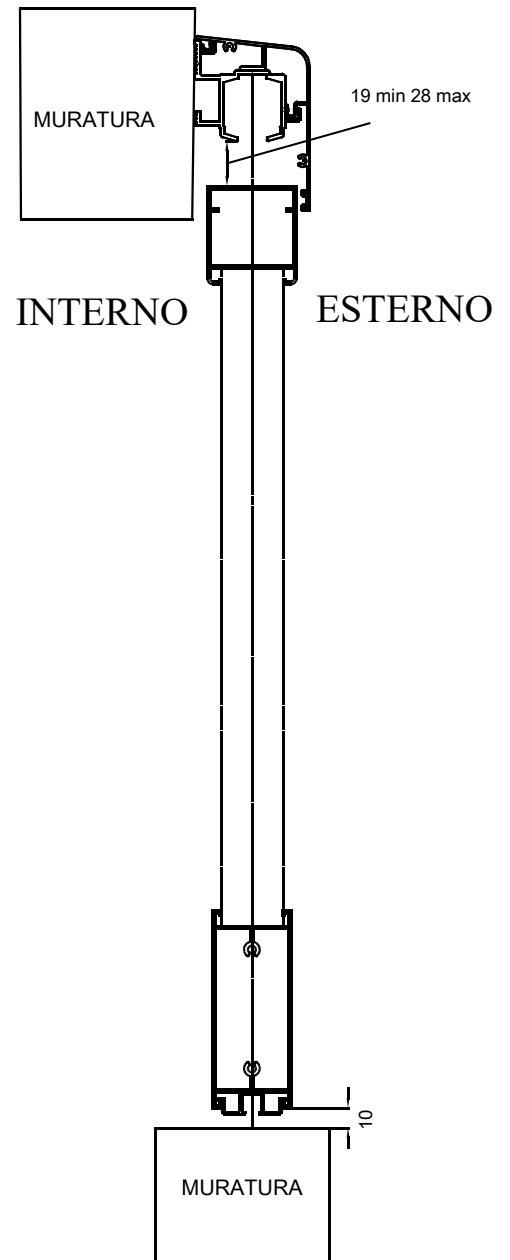

La persiana *Edera* è la soluzione ideale per gli edifici moderni. Il sistema di scorrimento laterale permette di risparmiare spazio in apertura e chiusura delle imposte, disegnando sulla facciata di casa vostra linee particolari e ben definite. Con un semplice gesto potete spostare la persiana lungo la parete, opzione particolarmente interessante in presenza di aperture di grandi dimensioni.

## Sezione orizzontale:

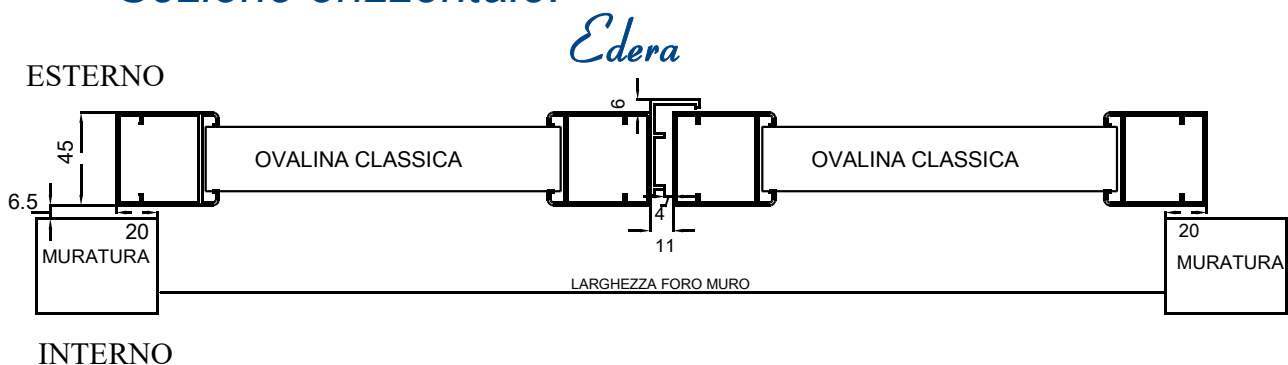

## Antone in alluminio



L' antone *Abete* si caratterizza con una superficie a tavola liscia formata da un pannello ad isolamento termico incastonato nella cornice perimetrale dell'anta che risalta la struttura portante sia esternamente che internamente. L'armonia tra la superficie liscia e la bordatura sobria del telaio conferisce all'antone un'estetica perfettamente equilibrata in dimensioni e forme mostrando allo stesso tempo eleganza ed attrazione.

Sono realizzabili tipologie a finestra e portafinestra ad una o più ante anche nella soluzione libro.

### Sezione orizzontale:

*Abete*

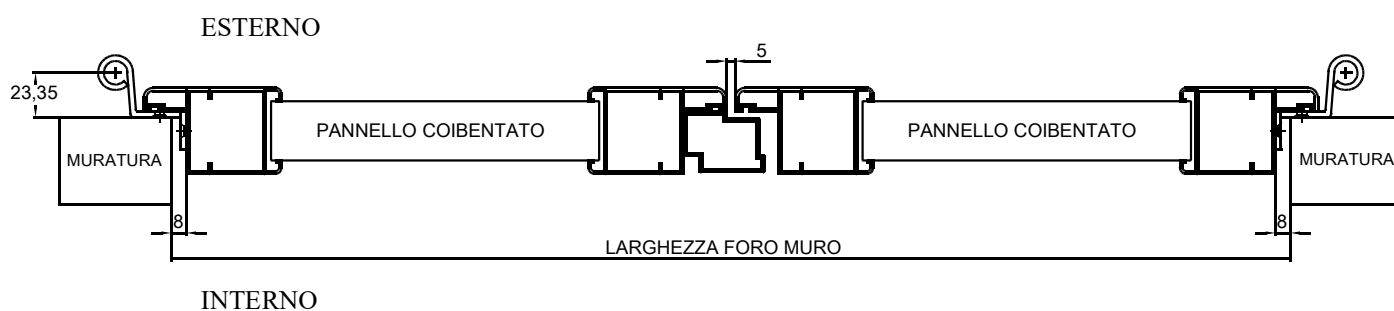



## Profili per persiane scorrevoli

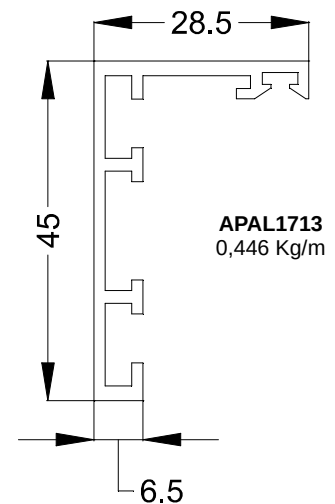
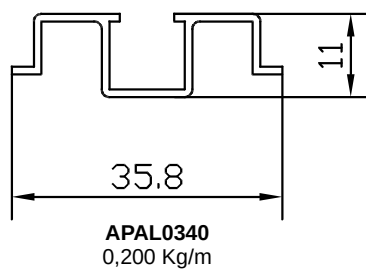
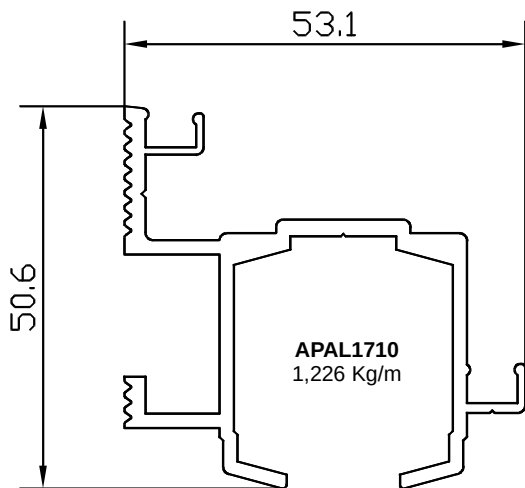
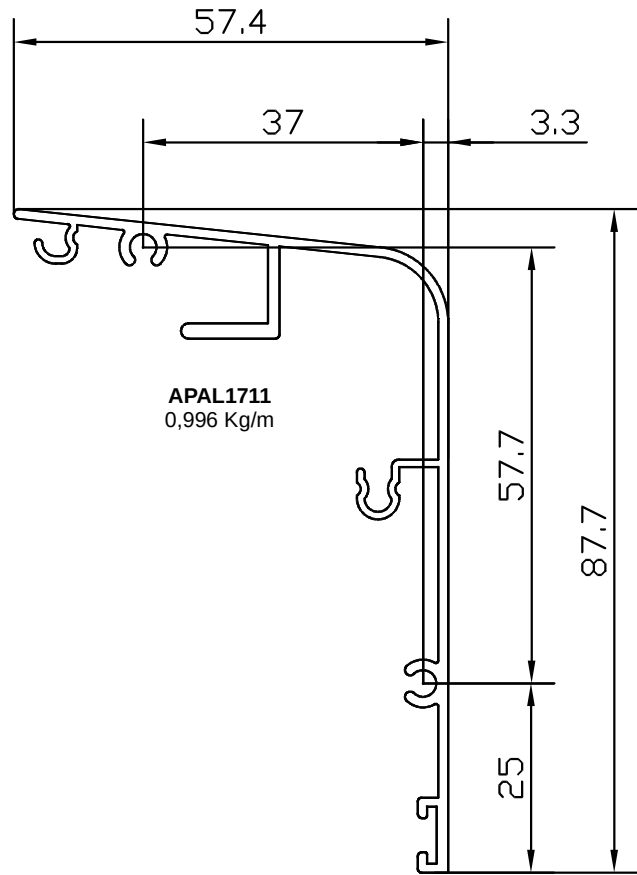
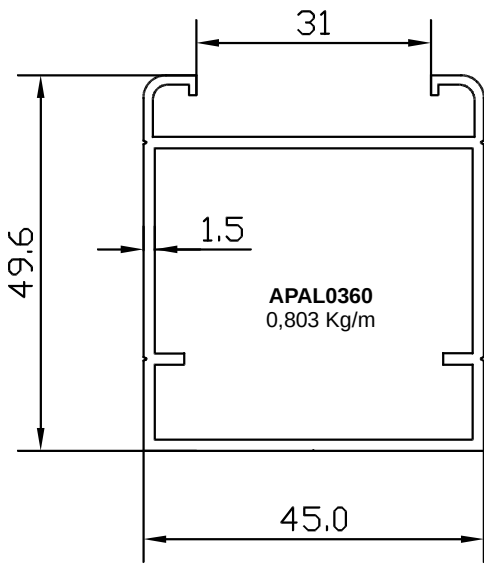



# TELAIO

catalogo  
persiane e scuri

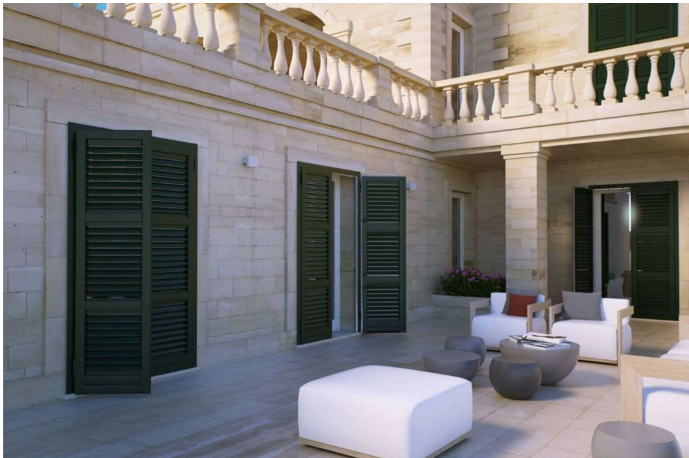

Sono disponibile diversi tipi di telaio con battuta mm: 37,8-55-75 (da specificare in fase d'ordine), sono realizzati con profilo estruso di nostra progettazione atto a ricevere ANTE MOBILI, vincolate da cerniere in alluminio di nuova concezione tecnologica con boccole antifrizione per alleggerirne la manovrabilità preservandone la durata del funzionamento nel tempo. Tamponamento delle ante mobili eseguito con ovaline/stecche estruse in alluminio di tipo tradizionale ad inclinazione fissa senza movimentazione con la possibilità di conferire un'ottima ventilazione all'interno anche a persiana chiusa ed una buona protezione per l'irraggiamento solare, chiusura delle ante per mezzo di spagnolette sistemate sul lato accessibile di manovra.

Le persiane realizzabile con telaio perimetrale sono:

- *Margherita*
- *Ninfea*
- *Girasole*
- *Ginestra*
- *Quercia*

Gli scuri realizzabile con telaio perimetrale sono:

- *Cedro*
- *Faggio*
- *Abete*
- *Castagno*

# TELAIO:



catalogo  
persiane e scuri

## SINGOLA BATTUTA

## EXTRA

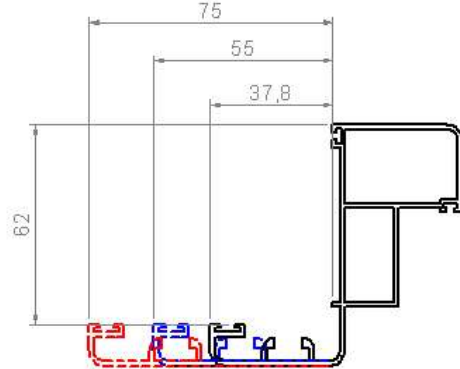
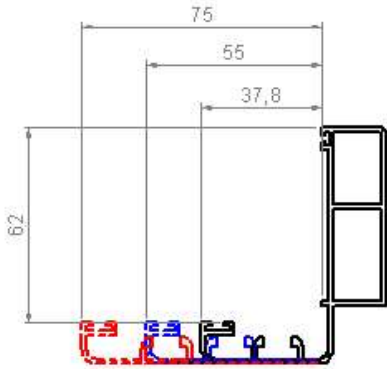

*Profilo telaio con battuta 37,8/55/75 mm*

## COMPATTO

## MINIMAL

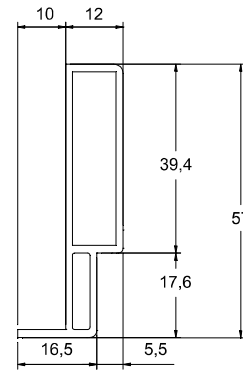
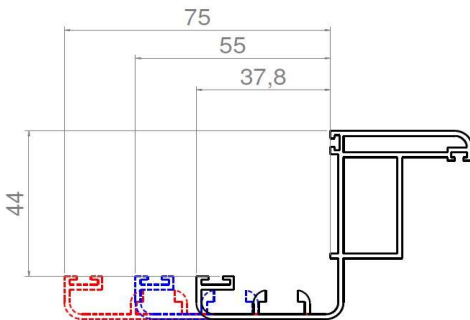

*Profilo telaio con battuta 37,8/55/75 mm*

*Profilo telaio con battuta 10mm*

*Esempio:*

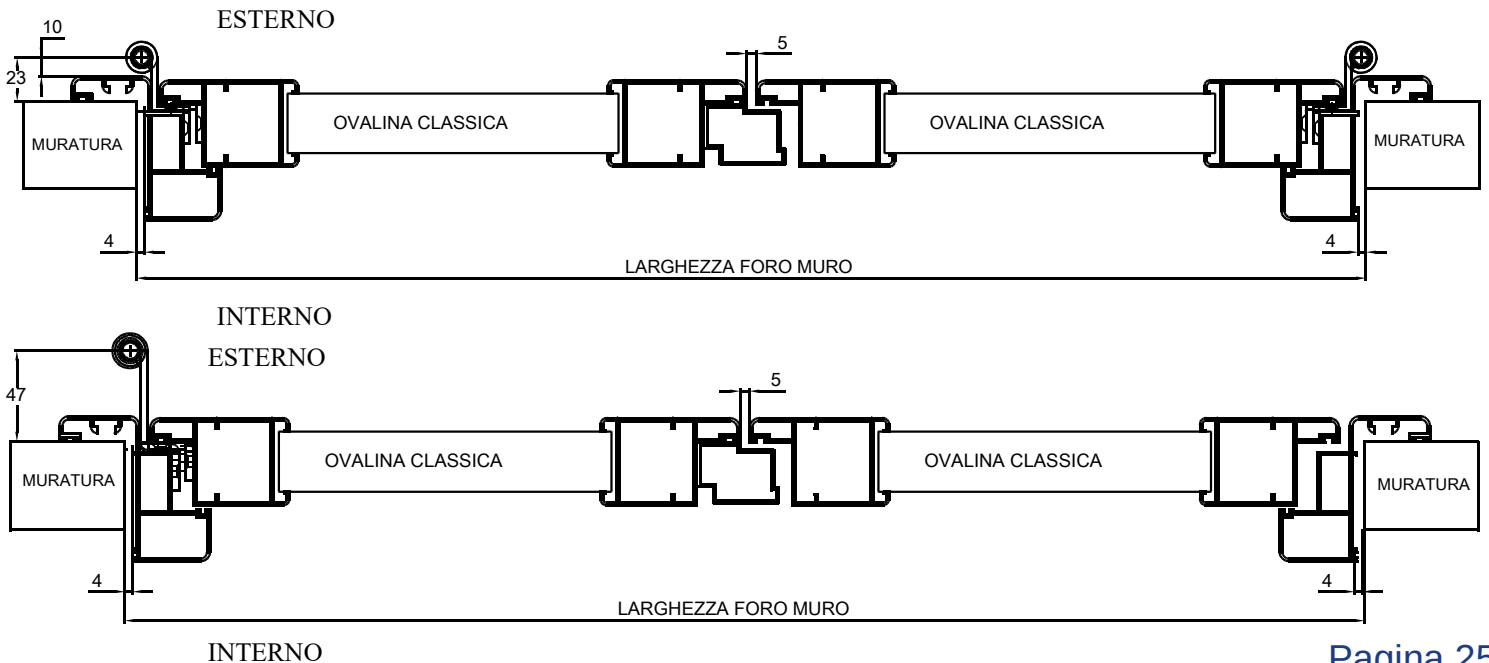

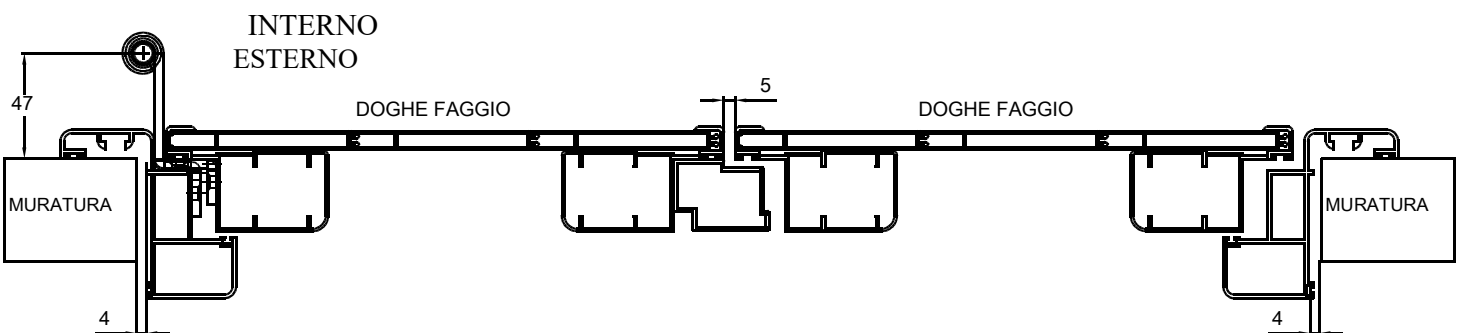
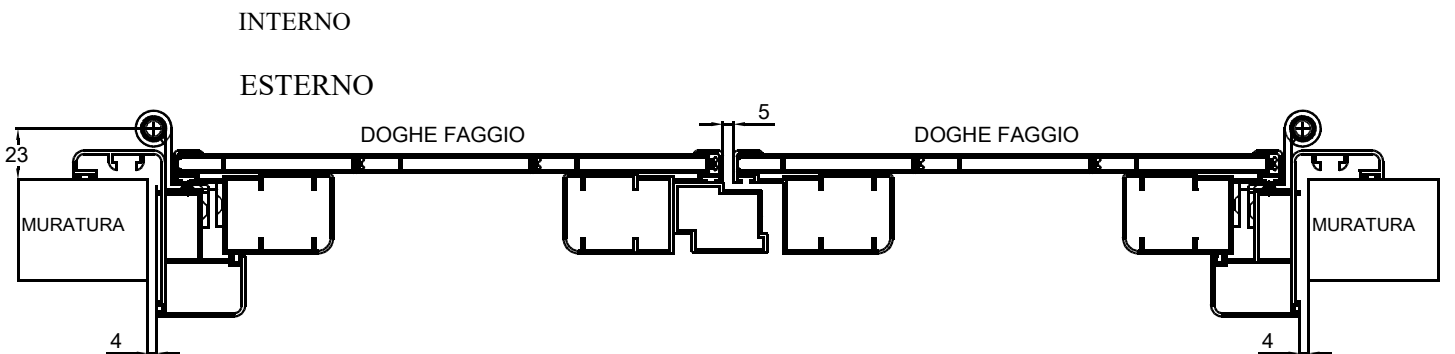
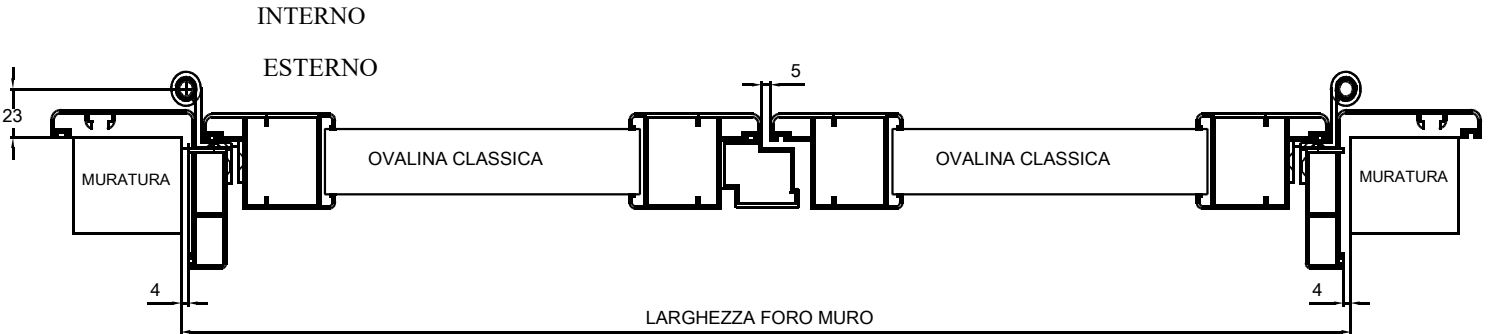
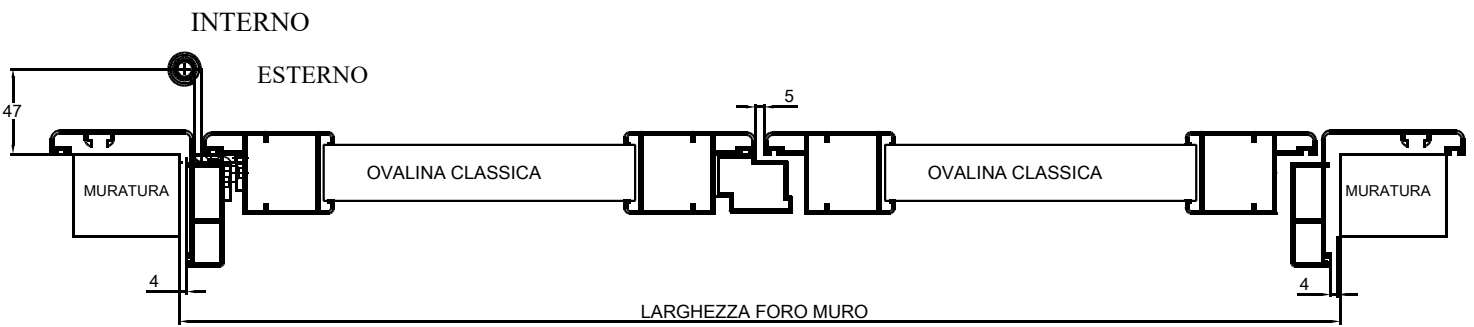
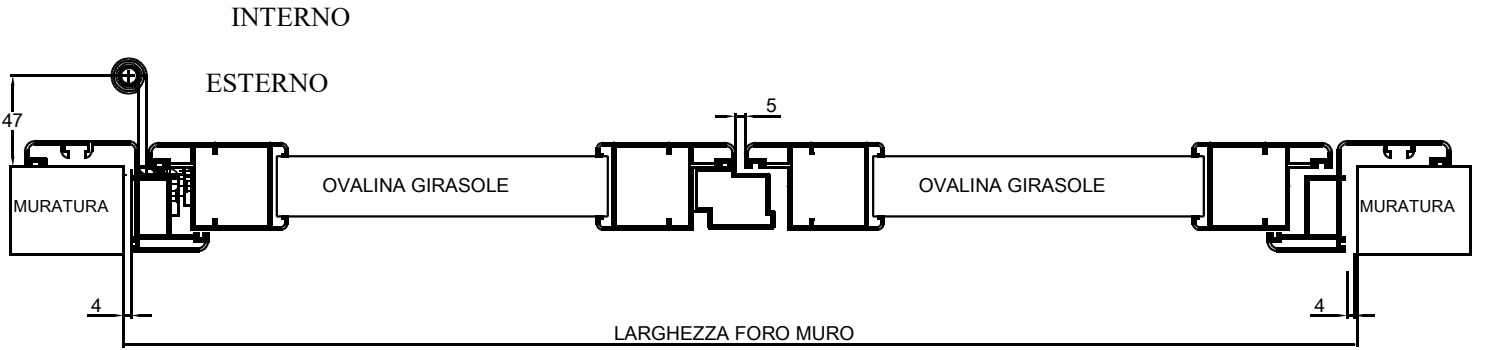
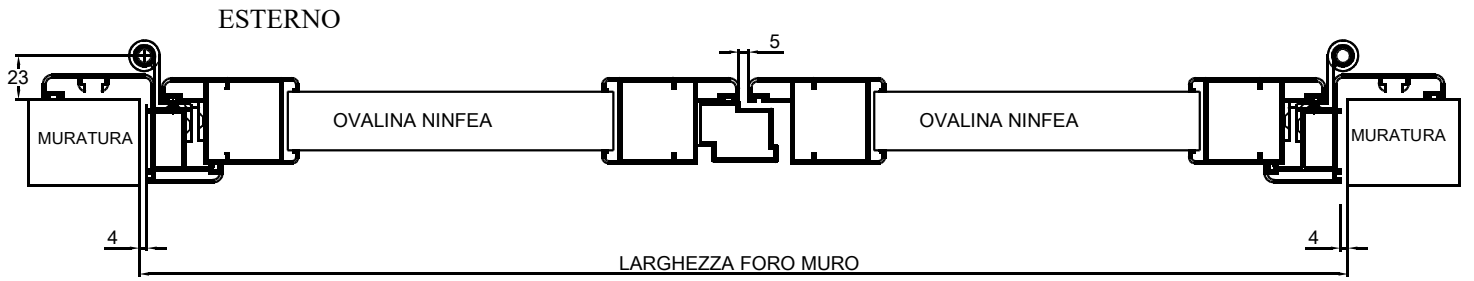

INTERNO

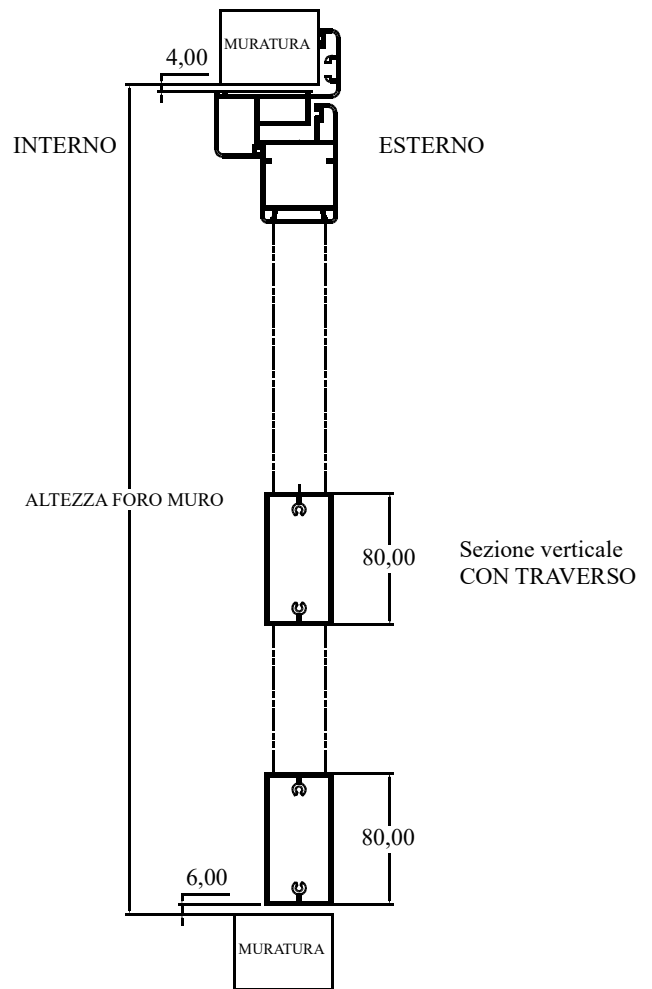
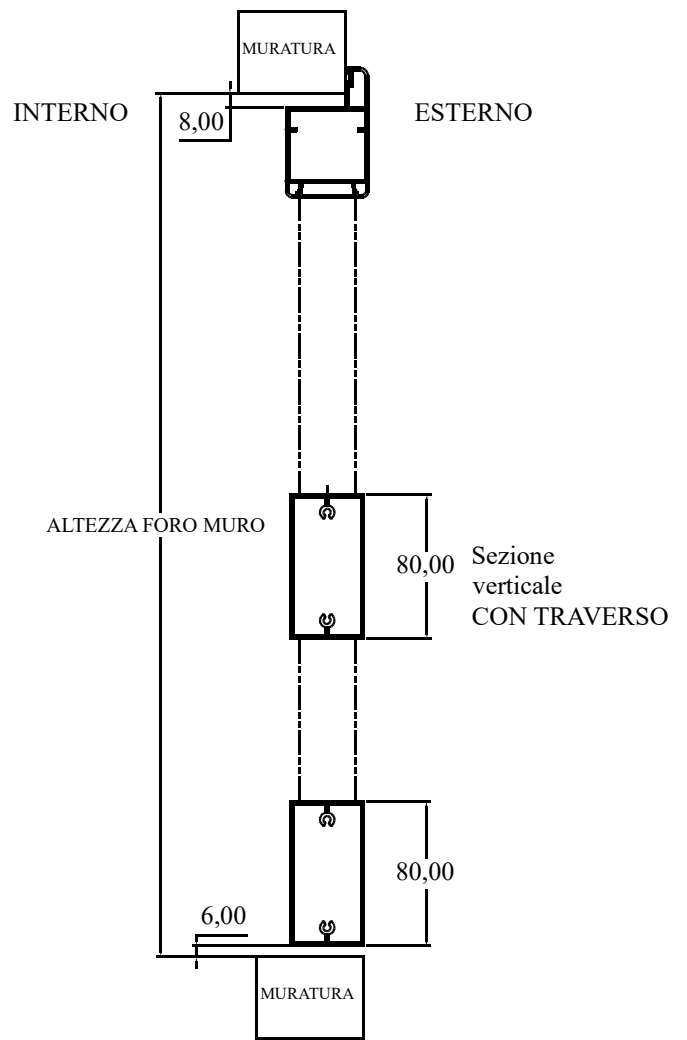
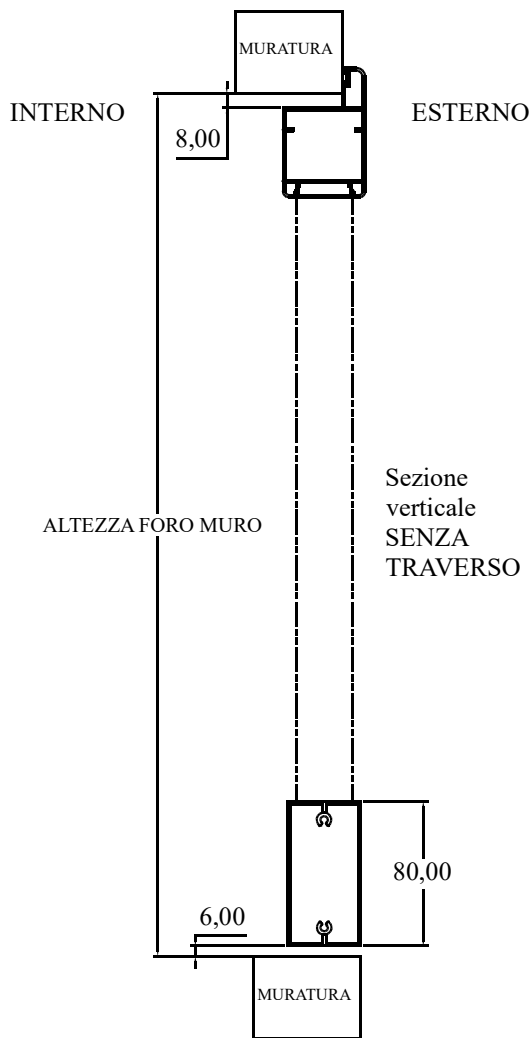

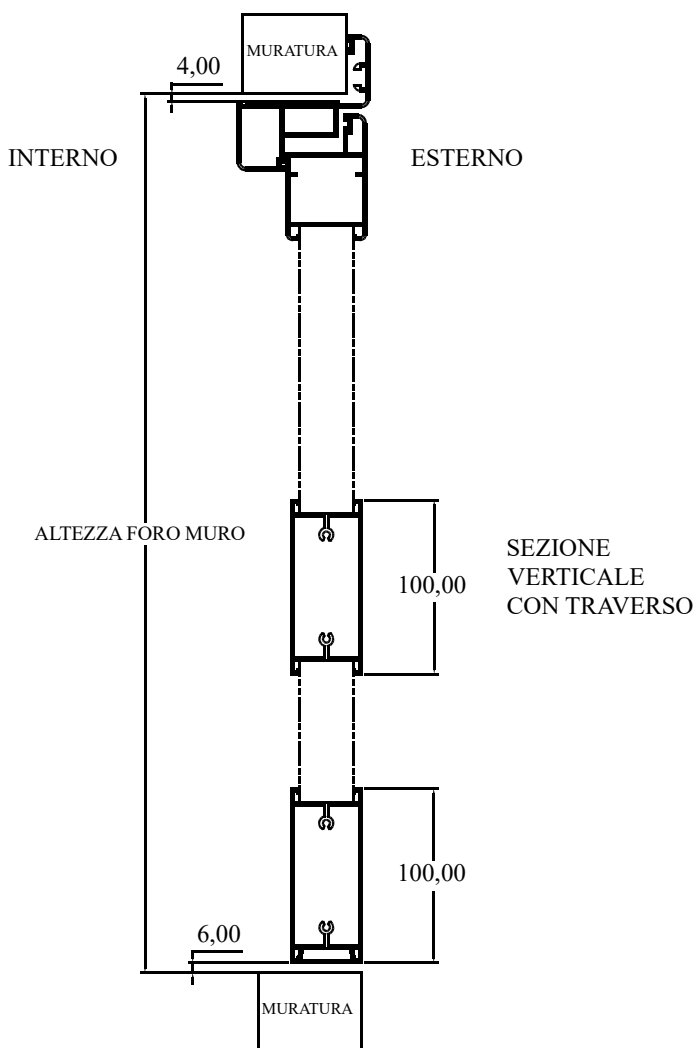
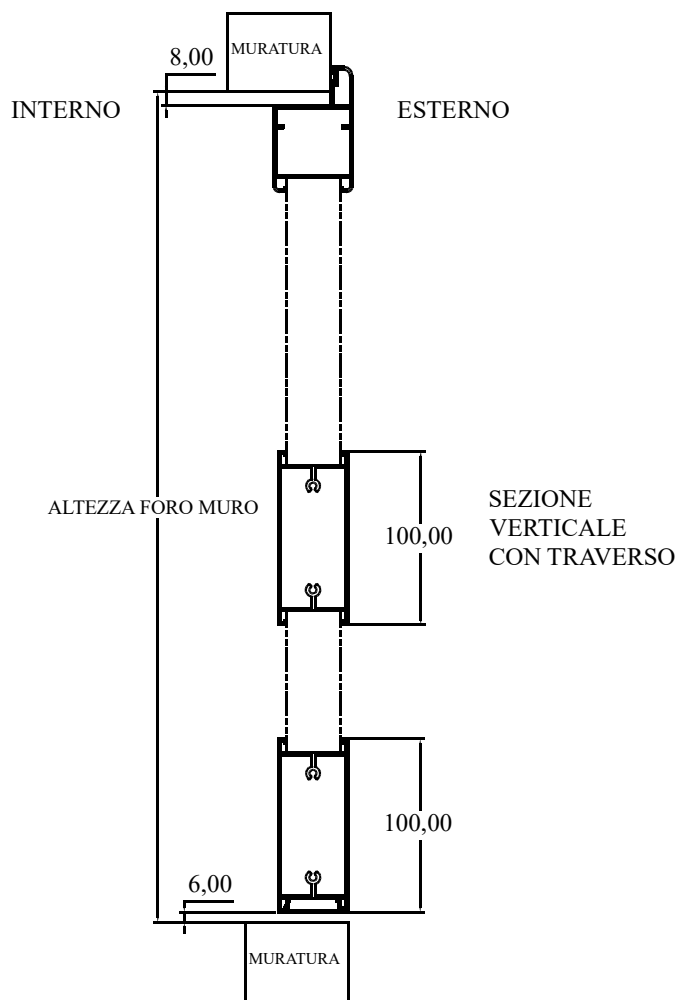
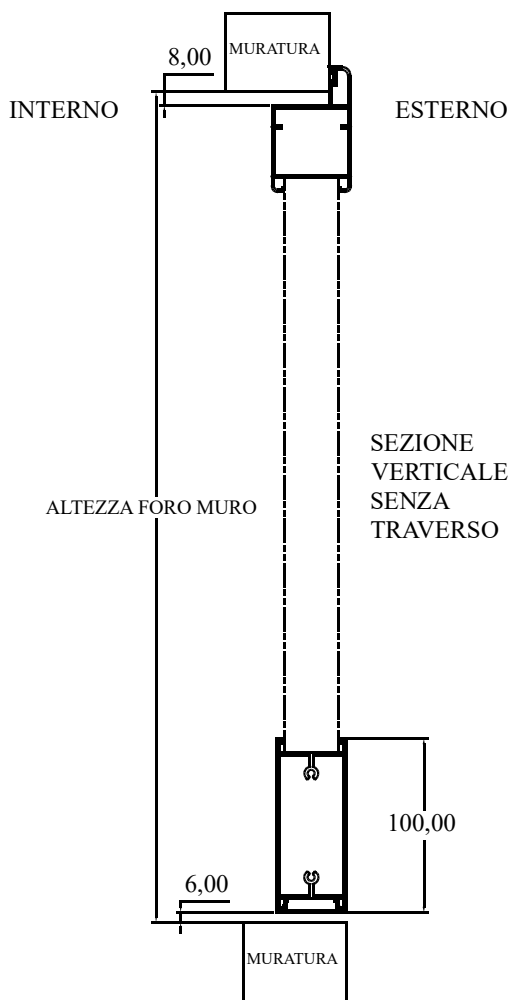

# SCHEMA DI POSIZIONAMENTO TRAVERSO E SPAGNOLETTA

## MODELLO MARGHERITA

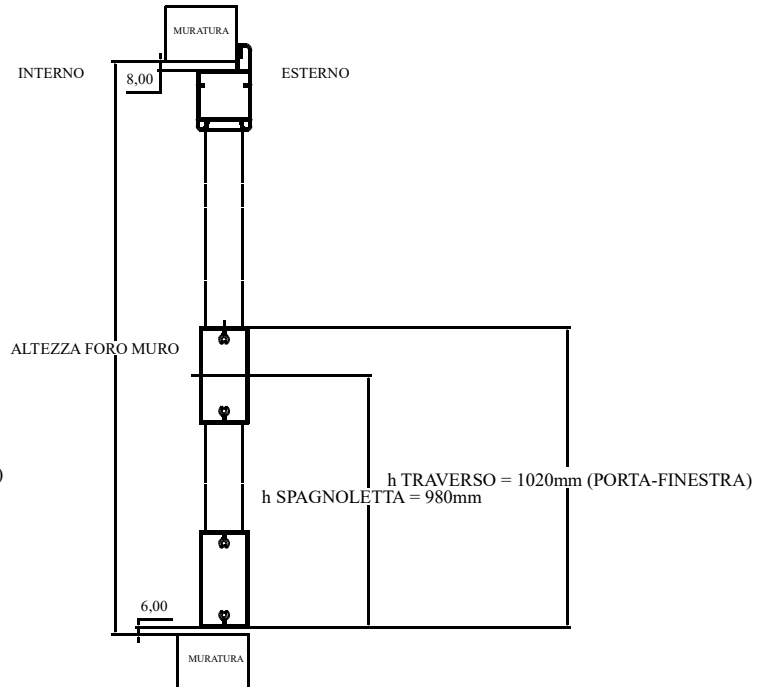
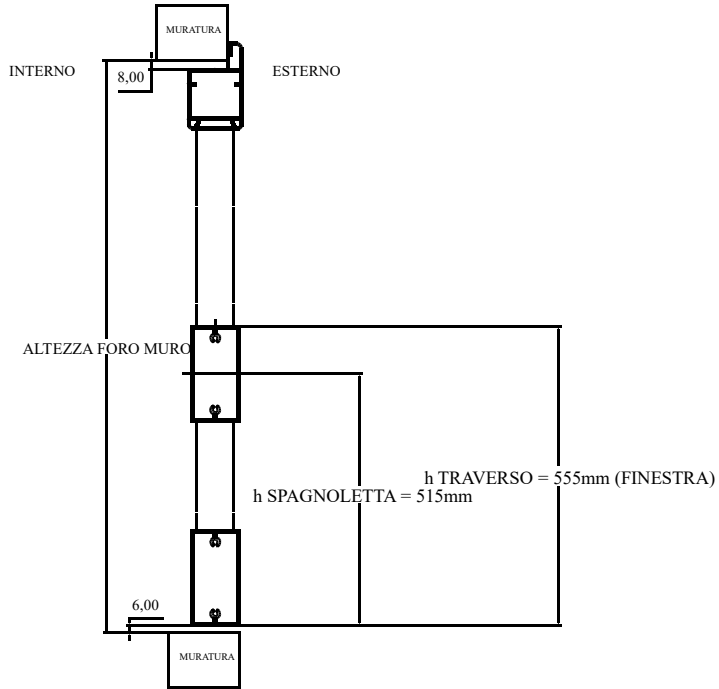

## MODELLO NINFEA – GIRASOLE - CEDRO

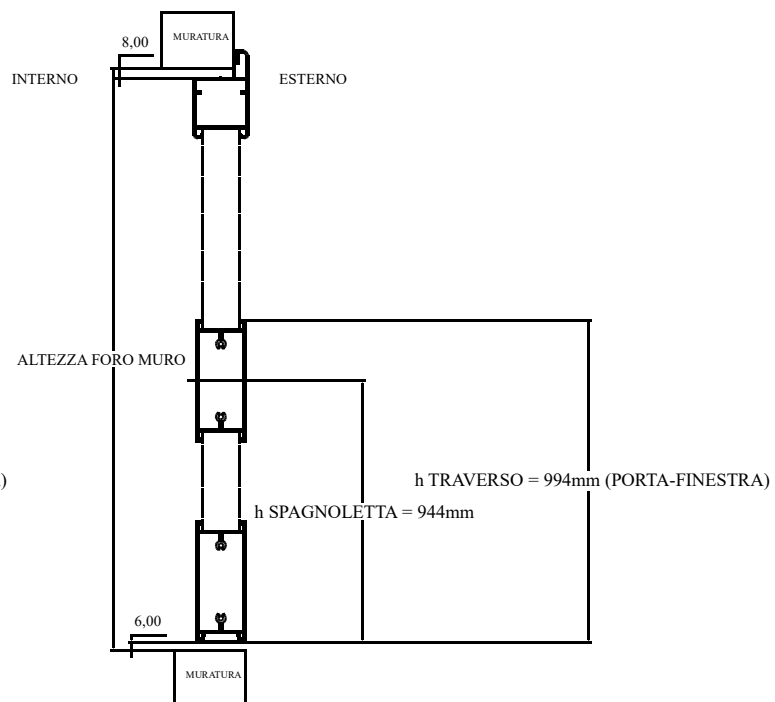
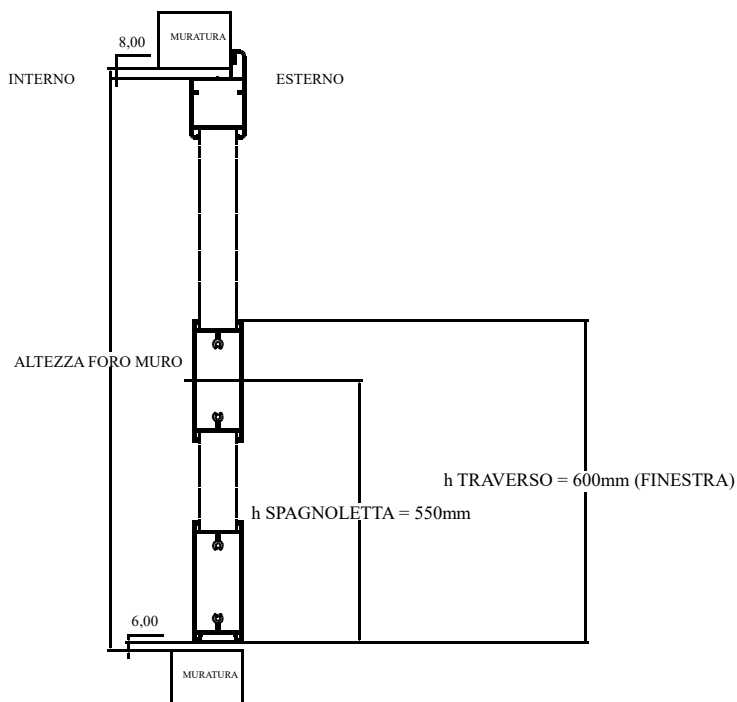

# SCHEMA DI POSIZIONAMENTO FISSAGGIO A MURO

## SCHEMA POSIZIONAMENTO FISSAGGIO A MURO

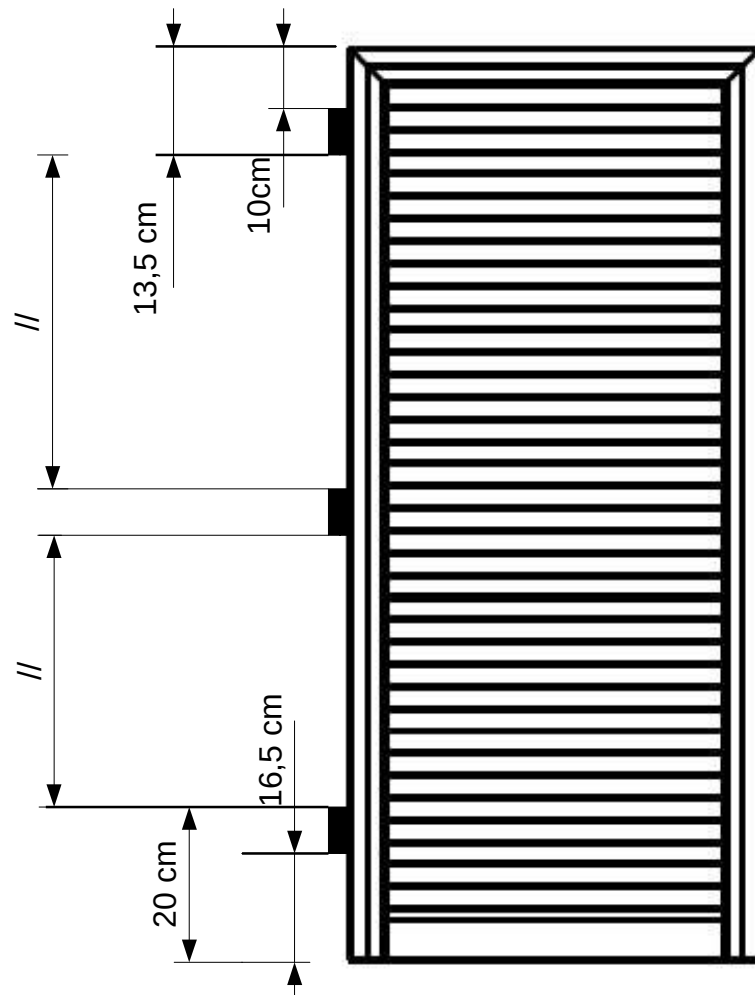

N.B. L'ALTEZZA DI FISSAGGIO DELLA BANDELLA CENTRALE E' VARIABILE DALL'ALTEZZA DELLA PERSIANA

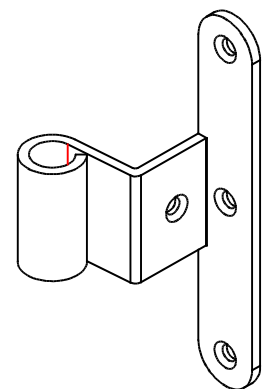
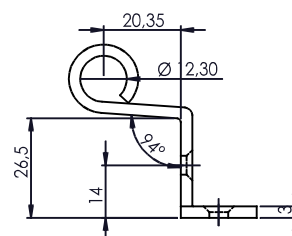
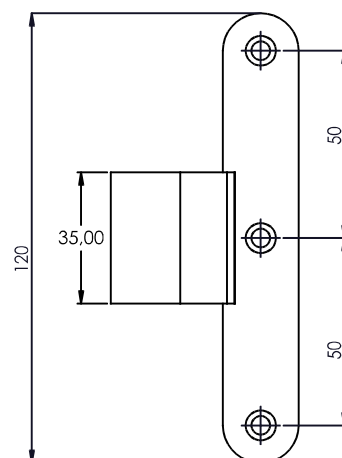
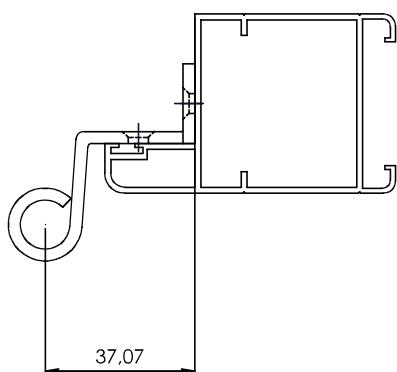



# Profili Telai

Profili telai doppia battuta abbinabili a ogni tipologia

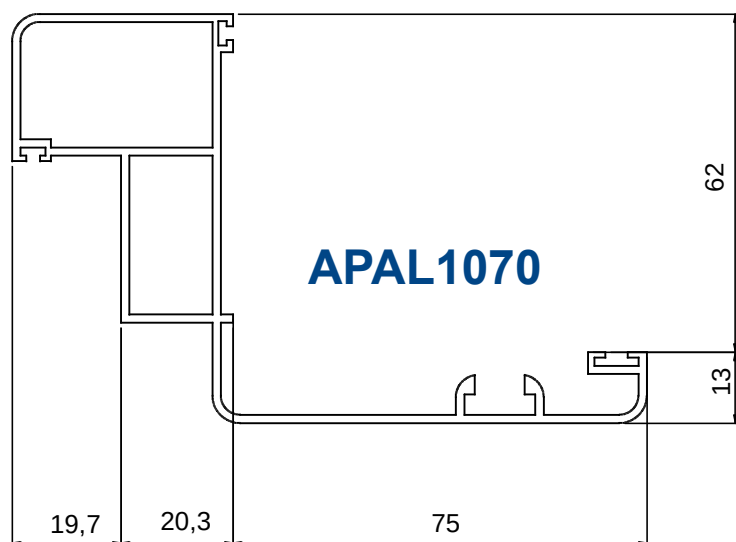
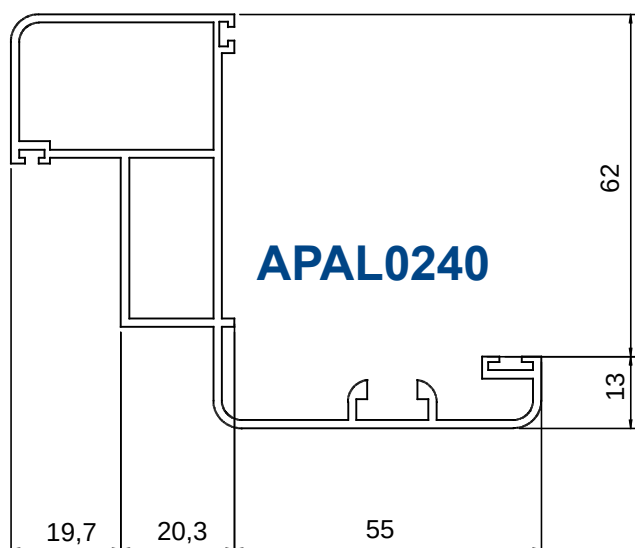
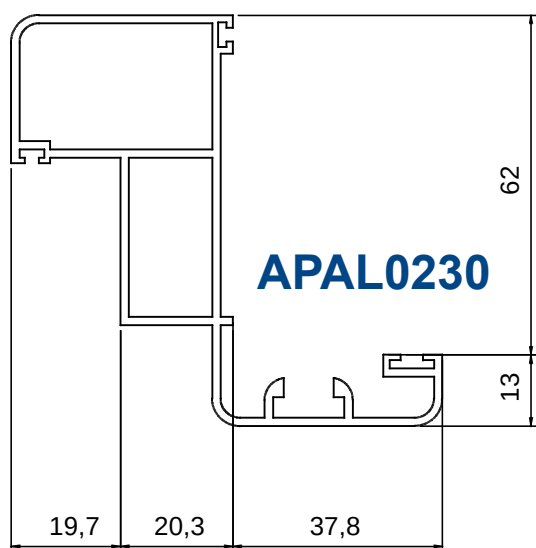

# Profili Telai

Profili telai doppia battuta compatto abbinabili a ogni tipologia

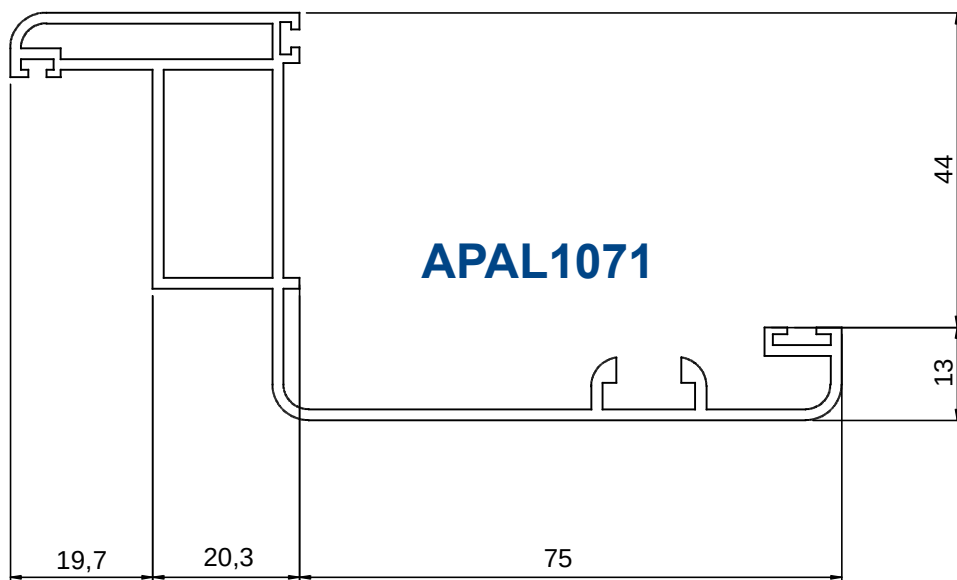
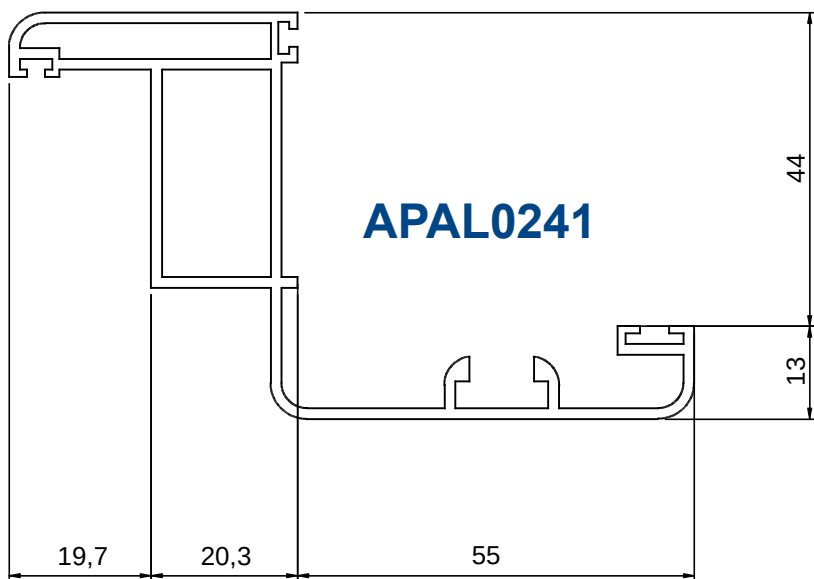
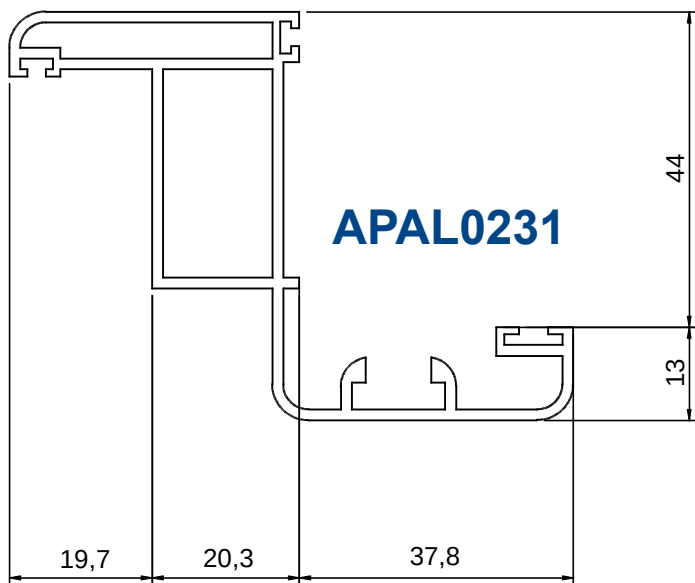

# Profili Jelai

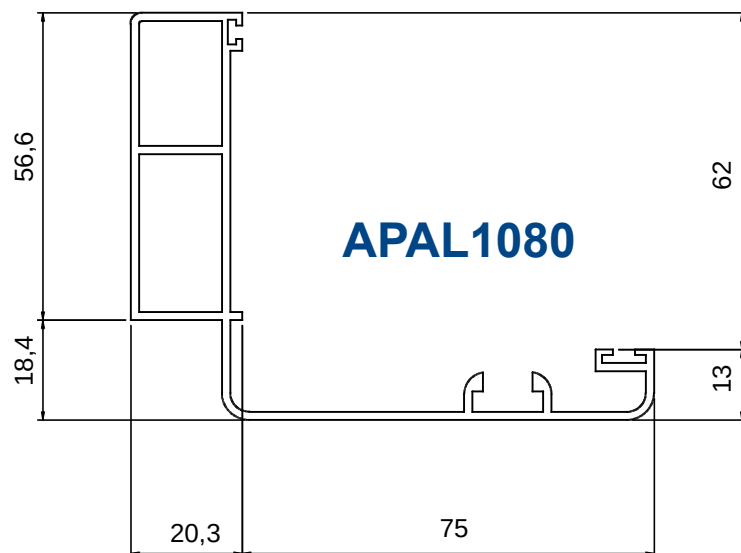
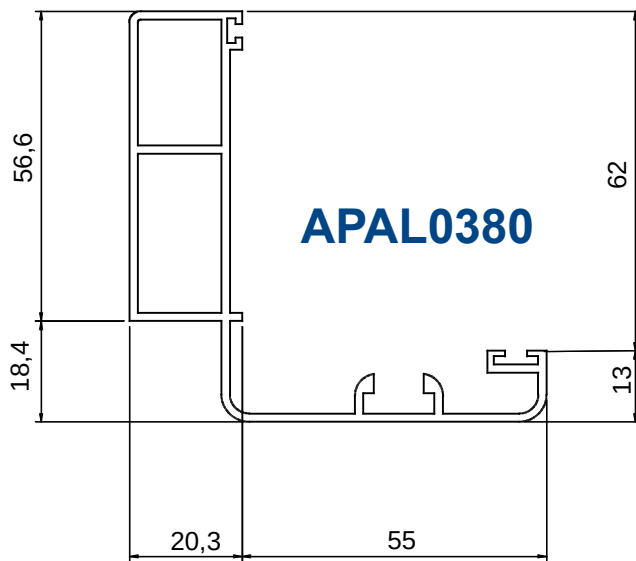
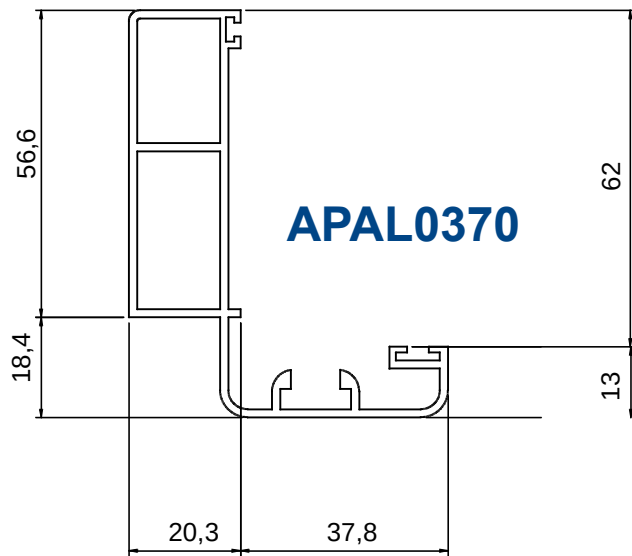



SAGOMA	ARTICOLO	DESCRIZIONE	 catalogo persiane e scuri
	PESO (Kg/m)		

	APAL0230	PROFILO TELAIO EXTRA 37,8mm
	1,190	

	APAL0240	PROFILO TELAIO EXTRA 55 mm
	1,307	

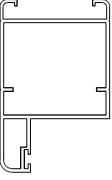
	APAL1070	PROFILO TELAIO CON EXTRA 75 mm
	1,388	

	APAL0251	PROFILO ANTA
	0,974	

	APAL0260	OVALINA
	0,300	

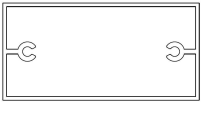
	APAL0270	FASCIA ZOCCOLO
	1,131	

	APAL0280	FASCIA ZOCCOLO ORIENTABILE
	1,200	

SAGOMA	ARTICOLO	DESCRIZIONE	 catalogo persiane e scuri
	PESO (Kg/m)		

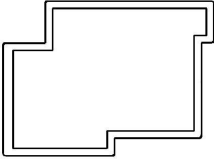
	APAL0290	RIPORTO BATTUTA
	0,585	

	APAL0301	OVALINA ORIENTABILE
	0,635	

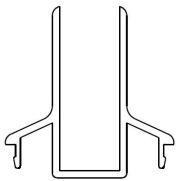
	APAL0310	PROFILO DI COMPENSAZIONE 1
	0,481	

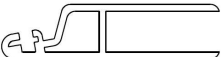
	APAL0320	PROFILO DI COMPENSAZIONE 2
	0,460	

	APAL0330	DOGA
	1,119	

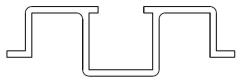
	APAL0340	SOTTO ZOCCOLO
	0,200	

	APAL0350	CHIUDI TUBOLARITA'
	0,129	

SAGOMA	ARTICOLO	DESCRIZIONE	 catalogo persiane e scuri
	PESO (Kg/m)		

	APAL0360	ANTA x SCORREVOLI
	0,803	

	APAL0370	PROFILO TELAIO 37,8 mm
	1,067	

	APAL0380	PROFILO TELAIO CON 55 mm
	1,136	

	APAL1080	PROFILO TELAIO CON 75 mm
	1,217	

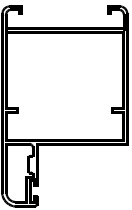
	APAL1691	ANTA LISCIA
	1,057	

	APAL1120	TELAIO MINIMAL
	0,579	

	APAL1130	BATTUTA RIPORTATA SPORTELLO GENOVESE
	0,213	

SAGOMA	ARTICOLO	DESCRIZIONE	 catalogo persiane e scuri
	PESO (Kg/m)		

	APAL1160	SPORTELLLO ALLA GENOVESE
	0,654	

	APAL1170	FASCIA ZOCCOLO CON BATTUTA 50mm
	0,890	

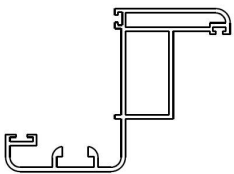
	APAL0231	PROFILO COMPATTO TELAIO 37,8 mm
	1,091	

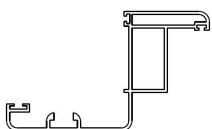
	APAL0241	PROFILO COMPATTO TELAIO 55 mm
	1,160	

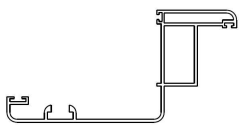
	APAL1071	PROFILO COMPATTO TELAIO 75 mm
	1,242	

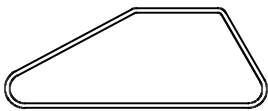
	APAL1365	OVALINA x NINFEA
	0,382	

	APAL1240	PERIMETRALE – PORTA SPAZZOLINO
	0,600	

SAGOMA	ARTICOLO	DESCRIZIONE	 catalogo persiane e scuri
	PESO (Kg/m)		

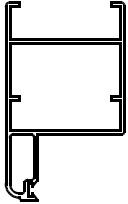
	APAL1320	ANTA CON BATTUTA A MURO x STORICA
	1,130	

	APAL1330	RIPORTO CENTRALE x STORICA
	0,643	

	APAL1340	FASCIA E ZOCCOLO x STORICA
	1,361	

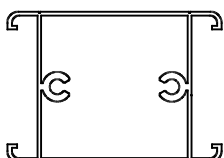
	APAL2130	PIANTONE
	0,251	

	APAL1360	FASCIA E ZOCCOLO x STORICA
	0,580	

	APAL1370	CHIUDI TUBOLARITA' x STORICA
	0,200	

	APAL1380	ANTA SENZA BATTUTA A MURO x STORICA
	0,807	



SAGOMA	ARTICOLO	DESCRIZIONE	 catalogo persiane e scuri
	PESO (Kg/m)		

	APAL1471	ANTA x FAGGIO
	0,811	

	APAL1481	DOGA x FAGGIO 80x8mm
	0,500	

	APAL1520	FASCIA PORTELLONE x FAGGIO
	0,613	

	APAL1530	SUPPORTO FASCIA x FAGGIO
	0,282	

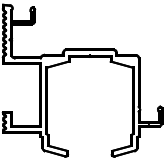
	APAL1710	BINARIO x EDERA
	1,226	

	APAL1711	MANTOVANA x EDERA
	0,996	

	APAL1713	RIPORTO CENTRALE x EDERA
	0,446	



**APAL0070**  
Squadretta per anta

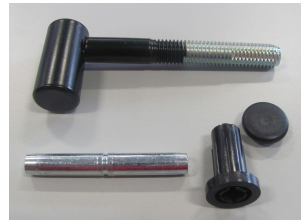
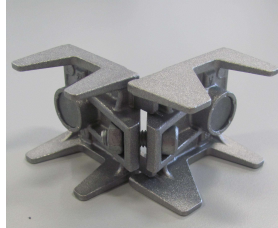

**APAL0840**  
Cardini a muro  
L= 90mm – M12

**APAL0080**  
Squadretta per telaio



**APAL0845**  
Cardini a muro  
L= 120mm – M12

**APAL0490**  
Squadretta per  
allineamento telaio

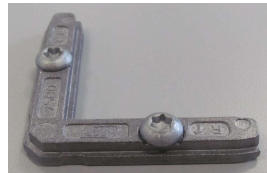

**APAL0844**  
Cardini a muro  
L= 180mm – M12

**APAL0490**  
Squadretta per  
Anta mod.Faggio



**APAL0851**  
Cardini a muro  
L= 100mm – M12

**APAL0470**  
Tappo terminale  
Anta persiana



**APAL0852**  
Cardini a muro  
L= 145mm – M12

**APAL0480**  
Tappo riporto  
centrale

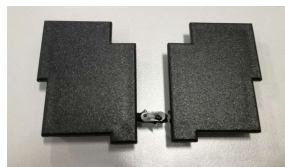

**APAL0853**  
Cardini a muro  
L= 200mm – M14

**APAL1241**  
Tappo porta spazzolino  
mod.Faggio

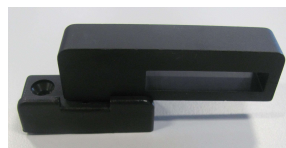

**APAL0652**  
Tragetta

**APAL1720**  
Tappi per mantovana



**APAL1726**  
Kit carrelli per scorrevoli

**AGB**  
Kit serratura ariete



**DOSTEBA**  
Elementi di supporto cardini

## APAL0173

Bandella a scomparsa  
Lama ridotta 12cm  
Zanca 22 senza reg.lat.



## APAL0172

Bandella a scomparsa  
Lama ridotta 12cm  
Zanca 52 senza reg.lat.



## APAL0931

Bandella doppia a scomparsa  
Perno antisfil.ambidestro  
Alzata 23 mm gom.24,5mm  
Lungh.120



## APAL0932

Bandella doppia a scomparsa  
Perno antisfil.ambidestro  
Alzata 23 mm gom.52mm  
Lungh.120



## APAL1460

Spagnoletta standard AGB



## APAL0148

Spagnoletta standard MAICO



## APAL0149

Spagnoletta a scatto AGB



## APAL0142

Spagnoletta a scatto MAICO



## APAL0811

Piastra inferiore AGB



## APAL0906

Piastra inferiore MAICO

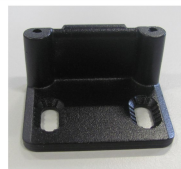

## APAL0161

Piastra a telaio AGB



## APAL905

Piastra a telaio MAICO



## APAL0816

Piastra a muro AGB



## APAL0817

Piastra a muro MAICO



## APAL0821

Guida asta AGB



## APAL0822

Guida asta MAICO



## APAL0162

Perno di chiusura per  
montaggio a filo AGB



## APAL0152

Perno di chiusura per  
montaggio a filo MAICO



## APAL0450

Fermapersiane  
singolo in plastica  
SPEEDY



## APAL0451

Fermapersiane doppio  
in plastica SPEEDY



## APAL0455

Fermapersiane singolo  
in ferro GHIDINI



## APAL0456

Fermapersiane doppio  
in ferro GHIDINI



## APAL1466

Fermapersiane  
singolo in nylon  
TORBEL 75/160



## APAL1467

Fermapersiane  
doppio in nylon  
TORBEL 65/200



## APAL1468

Fermapersiane  
singolo in nylon  
TORBEL 115/200



## APAL1469

Fermapersiane  
doppio in nylon  
TORBEL 144/280



## APAL0725

Tassello per cappotto  
per ferma imposte  
Grillo ESINPLAST



## APAL0726

Tassello per cappotto  
per ferma imposte  
Ghidini ESINPLAST



## APAL0727

Tassello per cappotto  
per cardine  
ESINPLAST







## Groppalli Srl

29010 Gragnano Trebbiense (PC) – Località Pilastro di Gragnanino – Tel.0523 789711

E-mail: [persiane@groppalli.it](mailto:persiane@groppalli.it) -[www.groppalli.it](http://www.groppalli.it)